



Interior

Iluminación



Chandur

SERIE



A Fijo / Redondo

Blanco Níquel Satín



B Basculante / Redondo

Blanco Níquel Satín



C Basculante / Cuadrado

Blanco Níquel Satín

Aros empotrables

Para lámparas dicroicas. Material: **aluminio fundido**. Portalámparas **GU10 incluido**.

Referencia	Artículo	Tipo	Forma	Potencia	Color	Dimensión	Empotr.	Embalaje
200405013	A	Fijo	Redonda	Máx. 50W	○ Blanco	Ø80x22mm	Ø66mm	10/100
200405014	A	Fijo	Redonda	Máx. 50W	● Níquel Satín	Ø80x22mm	Ø66mm	10/100
200405015	B	Basculante	Redonda	Máx. 50W	○ Blanco	Ø84x22mm	Ø74mm	10/100
200405016	B	Basculante	Redonda	Máx. 50W	● Níquel Satín	Ø84x22mm	Ø74mm	10/100
200405017	C	Basculante	Cuadrada	Máx. 50W	○ Blanco	84x84x22mm	Ø74mm	10/100
200405018	C	Basculante	Cuadrada	Máx. 50W	● Níquel Satín	84x84x22mm	Ø74mm	10/100

Undi

SERIE



A



B



C



D

Aros empotrables **anti deslumbramiento**

Forma: **redonda**. Para lámparas dicroicas.

Material: **PC**. Portalámparas **GU10 incluido**. IP20.

Referencia	Artículo	Tipo	Potencia	Color	Dimensión	Empotramiento	Embalaje
200405009	A	Fijo	Máx. 10W	○ Blanco mate	Ø89x28mm	Ø70mm	20/100
200405010	B	Fijo	Máx. 10W	● Negro mate	Ø89x28mm	Ø70mm	20/100
200405011	C	Basculante	Máx. 10W	○ Blanco mate	Ø85x28mm	Ø70mm	20/100
200405012	D	Basculante	Máx. 10W	● Negro mate	Ø85x28mm	Ø70mm	20/100

Fana

SERIE



Aros fijos empotrables

Tipo: **fijo**. Forma: **redonda**.

Para lámparas dicroicas. Material: **aluminio**. Portalámparas **GU10 incluido**. IP20.

Referencia	Potencia	Color	Dimensión	Empotramiento	Embalaje
200405003	Máx. 10W	○ Blanco mate	Ø77x25mm	Ø63mm	20/100
200405004	Máx. 10W	● Negro mate	Ø77x25mm	Ø63mm	20/100

Mebrat

SERIE



Aros basculantes empotrables

Tipo: **basculante**. Forma: **redonda**.

Para lámparas dicroicas. Material: **aluminio**. Portalámparas **GU10 incluido**. IP20.

Referencia	Potencia	Color	Dimensión	Empotramiento	Embalaje
200405005	Máx. 10W	○ Blanco mate	Ø84x25mm	Ø75mm	20/100
200405006	Máx. 10W	● Negro mate	Ø84x25mm	Ø75mm	20/100



A Basculante / Redondo



B Basculante / Redondo



C Basculante / Cuadrado

Aros basculantes empotrables

Para lámparas dicroicas. **Portalámparas GU10 incluido.** Material: **aluminio.**

Referencia	Artículo	Tipo	Forma	Potencia	Color	Dimensión	Empotr.	Embalaje
000705226	A	Basculante	Redonda	Máx. 50W	○ Blanco	Ø100x25mm	Ø72mm	10/100
000705227	B	Basculante	Redonda	Máx. 50W	○ Blanco	Ø105x33mm	Ø90mm	10/100
000705229	C	Basculante	Cuadrada	Máx. 50W	○ Blanco	105x105x33mm	90x90mm	10/100



Aro basculante empotrable 360°

Tipo: **basculante**. Forma: **cuadrada**. Material: **aluminio**.
Para lámparas dicroicas. **Portalámparas GU10 incluido**.

Referencia	Potencia	Color	Dimensión	Empotramiento	Embalaje
000705230	Máx. 50W	○ Blanco	110x110x55mm	97x97mm	5/50

Taitu SERIE

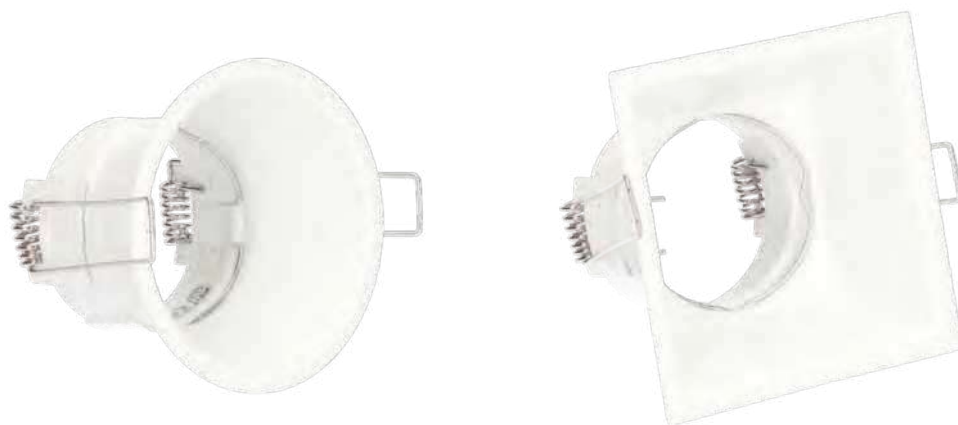

Aros fijos empotrables anti deslumbramiento

Tipo: **fijo**. Color: **blanco mate**.
Para lámparas dicroicas. Material: **aluminio**. **Portalámparas GU10 incluido**. IP20.

Referencia	Potencia	Forma	Dimensión	Empotramiento	Embalaje
200405007	Máx. 10W	Redonda	Ø82x65mm	Ø72x65mm	20/100
200405008	Máx. 10W	Cuadrada	88x88x70mm	Ø78x70mm	20/100

Pawne

ARO



Aro empotrable anti deslumbramiento

Tipo: **fijo empotrable**. Material: **aluminio**.
Para lámparas dicroicas. **Portalámparas GU10 incluido**.

Referencia	Potencia	Dimensión	Empotramiento	Embalaje
200405001	Máx. 50W	Ø90x45mm	Ø75mm	10/100

Osages

ARO



Especial
para baños



IP44

Aro empotrable

Tipo: **fijo empotrable**. Material: **aluminio**. Para lámparas dicroicas. **Portalámparas GU10 incluido**.
Bombilla no incluida. Altura de bombilla una vez instalada: 80mm. No aconsejable para techos muy bajos.

Referencia	Potencia	Dimensión	Empotramiento	Embalaje
200405002	Máx. 50W	Ø84x55mm	Ø75mm	10/100

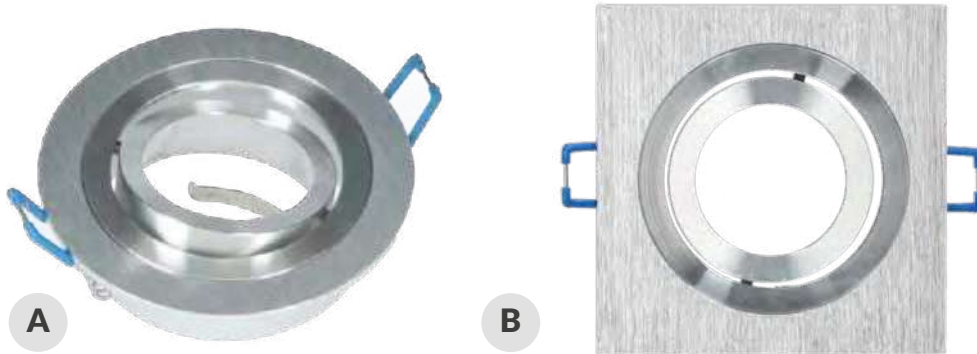

Aros basculantes

Empotrable liso. Para lámparas microicas. **Portalámparas GU10 incluido.**
Color: níquel satín. Potencia: máx. 50W. Material: **aluminio.**

Referencia	Artículo	Forma	Potencia	Dimensión	Empotramiento	Embalaje
000701952	A	Redondo	Máx. 50W	Ø90mm	Ø75mm	10/100
000701953	B	Cuadrado	Máx. 50W	90x90mm	75x75mm	100

Danbi

ARO

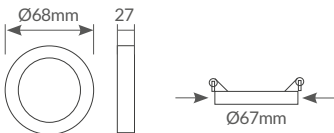

- 3000K
- 6000K
- 80°
- 100.000
- ≥80Ra
- 30.000h.
- 110-260V
- 50Hz

Aro redondo LED SMD

Desmontable **empotrable / superficie.** LED driver incluido. Color: **níquel satín.**

Referencia	Potencia	Lúmenes	Luz	Embalaje
200400008	3W	300Lm	3000K	200
200400009	3W	300Lm	6000K	200



Lumati

SERIE



Interior Aritos

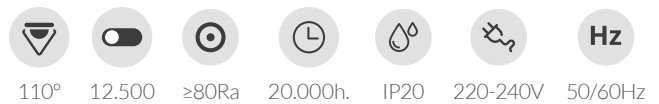
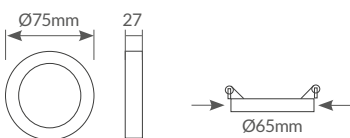
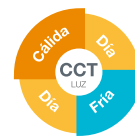

Aro redondo LED empotrable compacto

Cambio de tonalidad de luz a través de un botón. Material: **PP + PS**. LED driver incluido. Uso interior. Longitud cable: 100mm. Su **diseño compacto** permite instalarlos en techos como el pladur donde no hay mucho espacio con el techo.

Referencia	Artículo	Potencia	Lúmenes (360°)	Luz	Color	Embalaje
200400010	A	4W	350Lm	CCT (3000-4000-6000K)	○ Blanco	100
200400011	B	4W	350Lm	CCT (3000-4000-6000K)	● Negro	100
200400012	A	7W	600Lm	CCT (3000-4000-6000K)	○ Blanco	100
200400013	B	7W	600Lm	CCT (3000-4000-6000K)	● Negro	100

Lúbia

MÓDULO LED

 Ideal **espacios reducidos**



60°

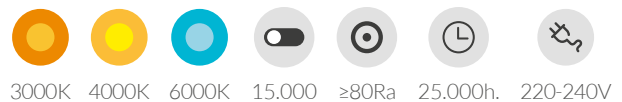
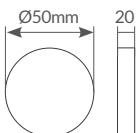
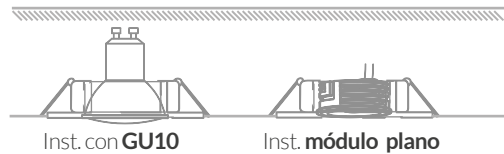

Módulo LED plano para focos y aros empotrables 60°

Tipo: **fijo empotrable**. Material: **cerámico**. Ideal para **espacios reducidos** donde no caben bombillas GU10. Longitud cable: 100mm.

Referencia	Potencia	Lúmenes útiles (90°)	Lúmenes nominales (360°)	Luz	Ángulo apertura	Embalaje
200621060	6.5W	510Lm	640Lm	 3000K	60°	10/100
200621061	6.5W	510Lm	640Lm	 4000K	60°	10/100
200621062	6.5W	510Lm	640Lm	 6000K	60°	10/100

Andulo

MÓDULO LED



Ideal **espacios reducidos**





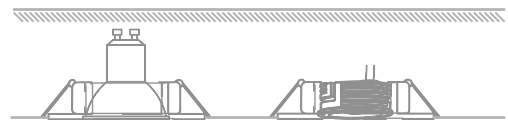



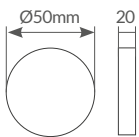

120°



Inst. con **GU10**



Inst. **módulo plano**



-  3000K
-  4000K
-  6000K
-  15.000
-  ≥80Ra
-  25.000h.
-  220-240V

Módulo LED plano para focos y aros empotrables 120°

Tipo: **fijo empotrable**. Material: **cerámico**. Ideal para **espacios reducidos** donde no caben bombillas GU10. Longitud cable: 100mm.

Referencia	Potencia	Lúmenes	Luz	Ángulo apertura	Embalaje
200621063	6.5W	600Lm	 3000K	120°	10/100
200621064	6.5W	600Lm	 4000K	120°	10/100
200621065	6.5W	600Lm	 6000K	120°	10/100

Banok

SERIE



A



B



C



D

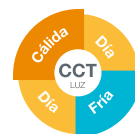
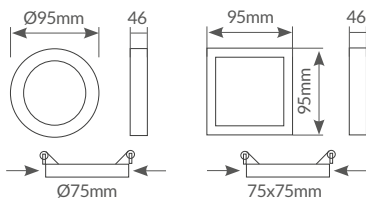

60°



15.000



≥80Ra



25.000h.



IP20



220-240V



50/60Hz

Aro basculante empotrable LED COB

Cambio de tonalidad de luz a través de un botón. Material: **plástico**. LED driver incluido. Uso interior.

Referencia	Artículo	Forma	Potencia	Lúmenes útiles (90°)	Lúmenes nominales (360°)	Luz	Color	Emb.
200400000	A	Redonda	7W	650Lm	740Lm	CCT (3000-4000-6500K)	○ Blanco	100
200400002	B	Redonda	7W	650Lm	740Lm	CCT (3000-4000-6500K)	● Negro	100
200400001	C	Cuadrada	7W	650Lm	740Lm	CCT (3000-4000-6500K)	○ Blanco	100
200400003	D	Cuadrada	7W	650Lm	740Lm	CCT (3000-4000-6500K)	● Negro	100

Mandani

SERIE



A



B



Antideslumbramiento

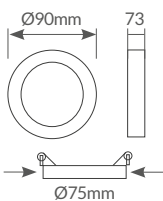
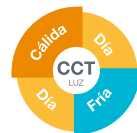

70°



15.000



≥80Ra



25.000h.



IP44



170-240V



50/60Hz

Aro empotrable LED COB

Cambio de tonalidad de luz a través de un botón. Material: **plástico**. LED driver incluido. Uso interior.

Referencia	Artículo	Forma	Potencia	Lúmenes útiles (90°)	Lúmenes nominales (360°)	Luz	Color	Emb.
200400014	A	Redonda	7W	550Lm	650Lm	CCT (3000-4000-6500K)	○ Blanco	100
200400015	B	Redonda	7W	550Lm	650Lm	CCT (3000-4000-6500K)	● Negro	100

Belur

EMPOTRABLE

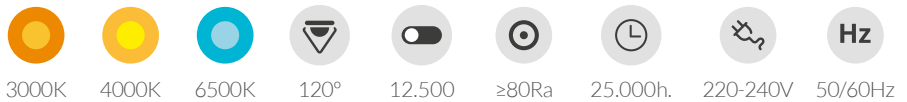
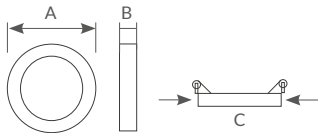

Downlight redondo empotrable de LED

Forma: **redonda**. LED driver incluido. Material: **PA + PS**. Color: blanco. Uso interior. IP40. IK02.

Referencia	Con difusor / Luminaria (360°)	Sin difusor / Fuente de luz (360°)	Luz	Dimensión (Ax B)	Empotramiento (C)	Embalaje
201000037	6W / 540Lm	6W / 600Lm	● 4000K	Ø120x23mm	Ø100-110mm	40
201000038	6W / 540Lm	6W / 600Lm	● 6500K	Ø120x23mm	Ø100-110mm	40
201000039	9W / 720Lm	9W / 850Lm	● 4000K	Ø150x23mm	Ø120-135mm	40
201000040	9W / 720Lm	9W / 850Lm	● 6500K	Ø150x23mm	Ø120-135mm	40
201000041	12W / 960Lm	12W / 1200Lm	● 4000K	Ø170x23mm	Ø140-160mm	40
201000042	12W / 960Lm	12W / 1200Lm	● 6500K	Ø170x23mm	Ø140-160mm	40
201000043	18W / 1440Lm	18W / 1850Lm	● 3000K	Ø225x23mm	Ø195-210mm	20
201000044	18W / 1440Lm	18W / 1850Lm	● 4000K	Ø225x23mm	Ø195-210mm	20
201000045	18W / 1440Lm	18W / 1850Lm	● 6500K	Ø225x23mm	Ø195-210mm	20
201000046	24W / 1920Lm	24W / 2500Lm	● 4000K	Ø225x23mm	Ø195-210mm	20
201000047	24W / 1920Lm	24W / 2500Lm	● 6500K	Ø225x23mm	Ø195-210mm	20

Belur

EMPOTRABLE

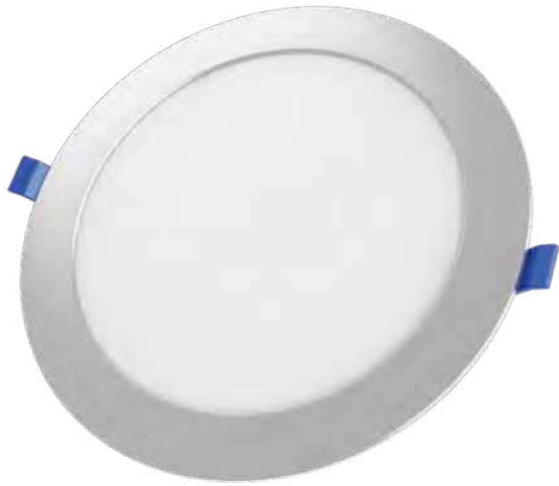

18W

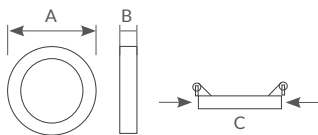

4000K



6500K



120°



12.500



≥80Ra



25.000h.



220-240V



50/60Hz

Downlight redondo empotrable de LED

Forma: **redonda**. LED driver incluido. Material: **PA + PS**. Color: blanco. Uso interior. IP40. IK02.

Referencia	Con difusor / Luminaria (360°)	Sin difusor / Fuente de luz (360°)	Luz	Color	Dimensión (AxB)	Empotramiento (C)	Emb.
201000062	18W / 1440Lm	18W / 1850Lm	● 4000K	● Gris	Ø225x23mm	Ø195-210mm	20
201000063	18W / 1440Lm	18W / 1850Lm	● 6500K	● Gris	Ø225x23mm	Ø195-210mm	20
201000065	18W / 1440Lm	18W / 1850Lm	● 4000K	● Negro	Ø225x23mm	Ø195-210mm	20
201000064	18W / 1440Lm	18W / 1850Lm	● 6500K	● Negro	Ø225x23mm	Ø195-210mm	20

Virey

EMPOTRABLE

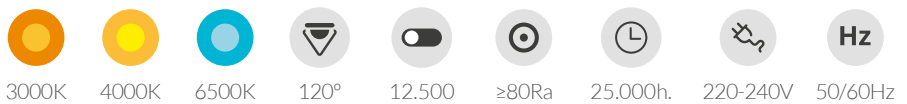
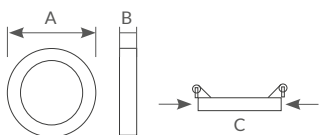
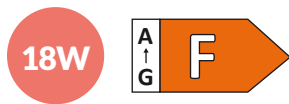

Downlight redondo empotrable de LED

Forma: **redonda**. LED driver incluido. Material: **aluminio + PS**. Color: blanco. Uso interior. IP40. IK02.

Referencia	Con difusor / Luminaria (360°)	Sin difusor / Fuente de luz (360°)	Luz	Dimensión (Ax B)	Empotramiento (C)	Embalaje
201000066	18W / 1440Lm	18W / 1800Lm	● 3000K	Ø225x13mm	Ø205mm	20
201000067	18W / 1440Lm	18W / 1800Lm	● 4000K	Ø225x13mm	Ø205mm	20
201000068	18W / 1440Lm	18W / 1800Lm	● 6500K	Ø225x13mm	Ø205mm	20

Lonbo
EMPOTRABLE

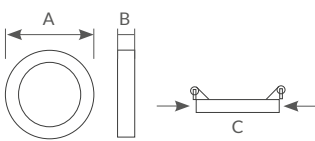
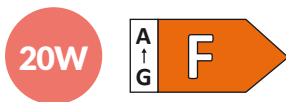





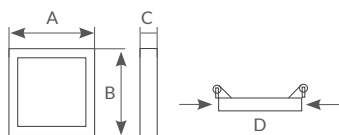
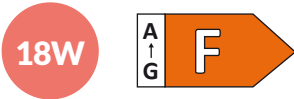

Downlight redondo empotrable de LED

Forma: **redonda**. LED driver incluido. Material: **aluminio + PS**. Color: blanco. Uso interior. **PF0.9**. IK02.

Referencia	Con difusor / Luminaria (360°)	Sin difusor / Fuente de luz (360°)	Luz	Dimensión (AxB)	Empotramiento (C)	Embalaje
201000080	20W / 1810Lm	20W / 2100Lm	● 3000K	Ø240x13mm	Ø225mm	20
201000076	20W / 1810Lm	20W / 2100Lm	● 4200K	Ø240x13mm	Ø225mm	20
201000077	20W / 1810Lm	20W / 2100Lm	● 6000K	Ø240x13mm	Ø225mm	20
201095004	Recambio driver para downlight Lonbo ref. 201000076 - 77					



Londa
EMPOTRABLE



-  4000K
-  6500K
-  120°
-  12.500
-  ≥80Ra
-  25.000h.
-  220-240V
-  Hz

Downlight cuadrado empotrable de LED

Forma: **cuadrada**. LED driver incluido. Material: **PC + PS**. Color: blanco. Uso interior. IP40. IK02.

Referencia	Con difusor / Luminaria (360°)	Sin difusor / Fuente de luz (360°)	Luz	Dimensión (AxBxC)	Empotramiento (D)	Embalaje
201000048	18W / 1440Lm	18W / 1850Lm	 4000K	225x225x24mm	208x208mm	20
201000049	18W / 1440Lm	18W / 1850Lm	 6500K	225x225x24mm	208x208mm	20

Interior Downlights

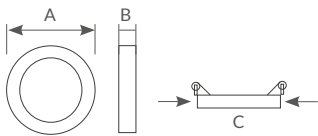
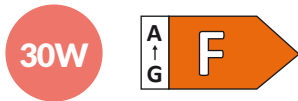

Downlight redondo empotrable LED

Forma: **redonda**. LED driver incluido. Material: **PC + aluminio**. Color: blanco. Uso interior. **IK05**.

Referencia	Potencia	Lúmenes	Luz	Dimensión (AxB)	Empotramiento	Embalaje
201000029	30W	3280Lm	● 4200K	Ø230x60mm	Ø200mm	10
201000070	30W	3280Lm	● 5500K	Ø230x60mm	Ø200mm	10

Aketi

EMPOTRABLE

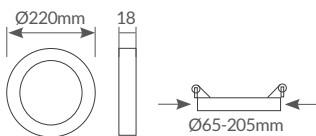
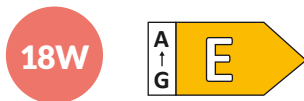

Downlight empotrable LED regulable con sensor

Forma: **redonda**. Downlight **empotrable o de superficie**.

Empotramiento regulable. Desde Ø65mm hasta Ø205mm. **Se adapta a diversos tamaños de agujeros.**

Temperatura regulable a través de botón. **Tiempo no regulable:** está encendido durante 30seg.

Sensor movimiento + fotoeléctrica: puede funcionar sólo de noche o de día y de noche.

Radio de detección: 3.5M (instalado en altura de 2.8M). LED driver incluido. Color: blanco. IK04.

Consumo stand-by: <0.5W. Material: **PC + Aluminio**.

Referencia	Con difusor / Luminaria (360°)	Sin difusor / Fuente de luz (360°)	Luz	Embalaje
201010006	18W / 1550Lm	18W / 1970Lm	3000K - 4000K - 6500K	20

* Consulta el esquema de detección en el apartado info técnica.

Larissa

EMPOTRABLE



Interior Downlights

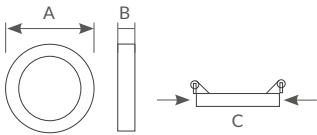

- 4200K
- 6500K
- 180°
- 15.000
- ≥80Ra
- 15.000h.
- 220-240V
- Hz

Downlight empotrable LED regulable

Forma: **redonda**. Empotramiento regulable. Se adapta a diversos tamaños de agujeros.
LED driver incluido. Material: **aluminio**. Color: blanco. Uso interior.

Referencia	Con difusor / Luminaria (360°)	Sin difusor / Fuente de luz (360°)	Luz	Dimensión (Ax B)	Empotramiento (C)	Embalaje
201000031	18W / 1646Lm	18W / 1867Lm	4200K	Ø120x22mm	Ø75-105mm (Reg.)	40
201000032	18W / 1646Lm	18W / 1867Lm	6500K	Ø120x22mm	Ø75-105mm (Reg.)	40
201000033	Recambio driver 18W					
201000034	36W / 3475Lm	36W / 4255Lm	4200K	Ø225x22mm	Ø75-205mm (Reg.)	20
201000035	36W / 3475Lm	36W / 4255Lm	6500K	Ø225x22mm	Ø75-205mm (Reg.)	20
201000036	Recambio driver 36W					

Nevale

EMPOTRABLE



Empotramiento regulable

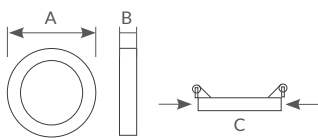
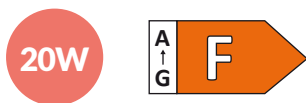

4200K



6000K



160°



10.000



≥80Ra



25.000h.



180-265V



50/60Hz

Downlight redondo empotrable LED regulable

Forma: **redonda**. Empotramiento regulable. Se adapta a diversos tamaños de agujeros.
LED driver incluido. Material: **aluminio**. Color: blanco. Uso interior.

Referencia	Potencia	Lúmenes	Luz	Dimensión (AxB)	Empotramiento	Embalaje
201000072	20W	2050Lm	● 4200K	Ø230x20mm	Ø50-210mm (Reg.)	20
201000073	20W	2050Lm	● 6000K	Ø230x20mm	Ø50-210mm (Reg.)	20
201095001	Recambio driver 20W					

Bogur
SUPERFICIE



6W

12W

18W

24W

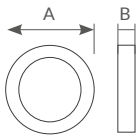

4000K



6500K



120°



12.500



≥80Ra



25.000h.



220-240V



50/60Hz

Downlight redondo superficie de LED

Forma: **redonda**. LED driver incluido. Material: **PA + PS**. Color: blanco. Uso interior. IP40. IK02.

Referencia	Con difusor / Luminaria (360°)	Sin difusor / Fuente de luz (360°)	Luz	Dimensión (AxBxC)	Embalaje
201005019	6W / 540Lm	6W / 600Lm	● 4000K	Ø120x28mm	40
201005020	6W / 540Lm	6W / 600Lm	● 6500K	Ø120x28mm	40
201005021	12W / 960Lm	12W / 1200Lm	● 4000K	Ø170x28mm	40
201005022	12W / 960Lm	12W / 1200Lm	● 6500K	Ø170x28mm	40
201005023	18W / 1440Lm	18W / 1850Lm	● 4000K	Ø225x28mm	20
201005024	18W / 1440Lm	18W / 1850Lm	● 6500K	Ø225x28mm	20
201005025	24W / 1920Lm	24W / 2500Lm	● 4000K	Ø225x28mm	20
201005026	24W / 1920Lm	24W / 2500Lm	● 6500K	Ø225x28mm	20

Vasan
SUPERFICIE

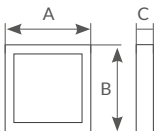
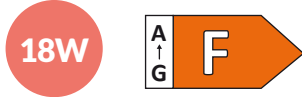

4000K



6500K



120°



12.500



≥80Ra



25.000h.



220-240V



50/60Hz

Downlight cuadrado superficie de LED

Forma: **cuadrado**. LED driver incluido. Material: **PC + PS**. Color: blanco. Uso interior. IP40. IK02.

Referencia	Con difusor / Luminaria (360°)	Sin difusor / Fuente de luz (360°)	Luz	Dimensión (AxBxC)	Embalaje
201005027	18W / 1440Lm	18W / 1850Lm	● 4000K	225x225x28mm	20
201005028	18W / 1440Lm	18W / 1850Lm	● 6500K	225x225x28mm	20

Gemena
SUPERFICIE



Casquillo
E27

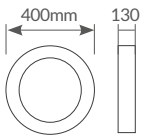

IP20



220-240V



50/60Hz

Plafón techo de tela 2xE27

Forma: **redonda**. Material: **tela + base metálica + difusor PC**. Uso interior.

Referencia	Potencia	Casquillo	Color	Embalaje
203600001	Máx. 60W	2xE27	○ Blanco	2
203600002	Máx. 60W	2xE27	● Negro	2
203600003	Máx. 60W	2xE27	● Celeste	2
203600004	Máx. 60W	2xE27	● Azul	2
203600005	Máx. 60W	2xE27	● Lavanda	2

Kasker

SUPERFICIE



22W

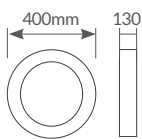

-  120°
-  100.000
-  ≥80Ra
-  25.000h.
-  IP20
-  220-240V
-  Hz

Plafón techo LED regulable

Forma: **redonda**. LED driver incluido. **Temperatura e intensidad regulable**.
 Con **memoria del último estado de color**.
Temporizador 30°. Modo noche. Incluye mando (utiliza 2 pilas AAA, incluidas).
 Material: **tela + base metálica + difusor PC**. Uso interior.

Referencia	Con difusor / Luminaria	Sin difusor / Fuente de luz (360°)	Luz	Color	Embalaje
203605069	22W / 900Lm	22W / 2000Lm	3000K - 6500K	● Gris	2
203605070	22W / 900Lm	22W / 2000Lm	3000K - 6500K	● Beige	2
203605071	22W / 900Lm	22W / 2000Lm	3000K - 6500K	○ Blanco	2

Elda

SUPERFICIE



Interior Plafones

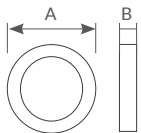

Plafón techo de LED

Forma: **redonda**. LED driver incluido. Material: **plástico**. Color: blanco. Uso interior.

Referencia	Con difusor / Luminaria (360°)	Sin difusor / Fuente de luz (360°)	Luz	Dimensión (AxB)	Embalaje
203605041	14W / 1190Lm	14W / 1380Lm	● 3000K	Ø260x65mm	10
203605042	14W / 1190Lm	14W / 1380Lm	● 4000K	Ø260x65mm	10
203605043	14W / 1190Lm	14W / 1380Lm	● 6500K	Ø260x65mm	10
203605044	20W / 1600Lm	20W / 2050Lm	● 3000K	Ø290x65mm	10
203605045	20W / 1600Lm	20W / 2050Lm	● 4000K	Ø290x65mm	10
203605046	20W / 1600Lm	20W / 2050Lm	● 6500K	Ø290x65mm	10
203605047	24W / 1920Lm	20W / 2500Lm	● 3000K	Ø340x65mm	10
203605048	24W / 1920Lm	20W / 2500Lm	● 4000K	Ø340x65mm	10
203605049	24W / 1920Lm	20W / 2500Lm	● 6500K	Ø340x65mm	10



Birai
SUPERFICIE

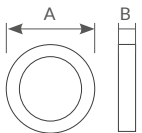

Plafón techo de LED

Forma: **redonda**. LED driver incluido. Material: **metal + PMMA**. Color: blanco. Uso interior.

Referencia	Con difusor / Luminaria (360°)	Sin difusor / Fuente de luz (360°)	Luz	Dimensión (Ax B)	Embalaje
203605089	12W / 900Lm	12W / 1160Lm	● 3000K	Ø260x75mm	10
203605090	12W / 900Lm	12W / 1160Lm	● 4000K	Ø260x75mm	10
203605091	12W / 900Lm	12W / 1160Lm	● 6500K	Ø260x75mm	10
203605092	18W / 1350Lm	18W / 1820Lm	● 3000K	Ø310x95mm	10
203605093	18W / 1350Lm	18W / 1820Lm	● 4000K	Ø310x95mm	10
203605094	18W / 1350Lm	18W / 1820Lm	● 6500K	Ø310x95mm	10
203605095	24W / 1800Lm	24W / 2500Lm	● 3000K	Ø350x95mm	10
203605096	24W / 1800Lm	24W / 2500Lm	● 4000K	Ø350x95mm	10
203605097	24W / 1800Lm	24W / 2500Lm	● 6500K	Ø350x95mm	10

Andra

SUPERFICIE

Interior Plafones

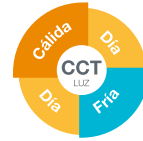

24W 30W

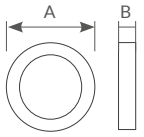

- 180°
- 15.000
- ≥80Ra
- 25.000h.
- IP44
- 220-240V
- 50/60Hz

Plafón techo LED

Forma: **redonda**. LED driver incluido.
Temperatura regulable: de 3000K a 6500K ofrece 10 tonalidades diferentes.
 Material: **plástico**. Uso interior.

Referencia	Con difusor / Luminaria	Sin difusor / Fuente de luz (360°)	Luz	Color	Dimensión (AxB)	Emb.
203605072	24W/ 1875Lm	24W/ 2500Lm	3000K - 6500K	● Negro	Ø295x55mm	6
203605073	24W/ 1875Lm	24W/ 2500Lm	3000K - 6500K	● Efecto madera	Ø295x55mm	6
203605074	30W/ 2400Lm	30W/ 3200Lm	3000K - 6500K	● Negro	Ø420x60mm	6
203605075	30W/ 2400Lm	30W/ 3200Lm	3000K - 6500K	● Efecto madera	Ø420x60mm	6

Andra
SUPERFICIE

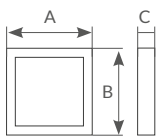
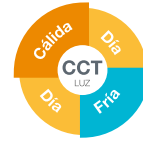

180°



15.000



≥80Ra



25.000h.



IP44



220-240V



50/60Hz

Plafón techo LED

Forma: **cuadrada**. LED driver incluido.

Temperatura regulable: de 3000K a 6500K ofrece 10 tonalidades diferentes.

Material: **plástico**. Uso interior.

Referencia	Con difusor / Luminaria	Sin difusor / Fuente de luz (360°)	Luz	Color	Dimensión (Ax B)	Embalaje
203605076	30W / 2400Lm	30W / 3200Lm	3000K - 6500K	● Negro	420x420x55mm	6

Melun



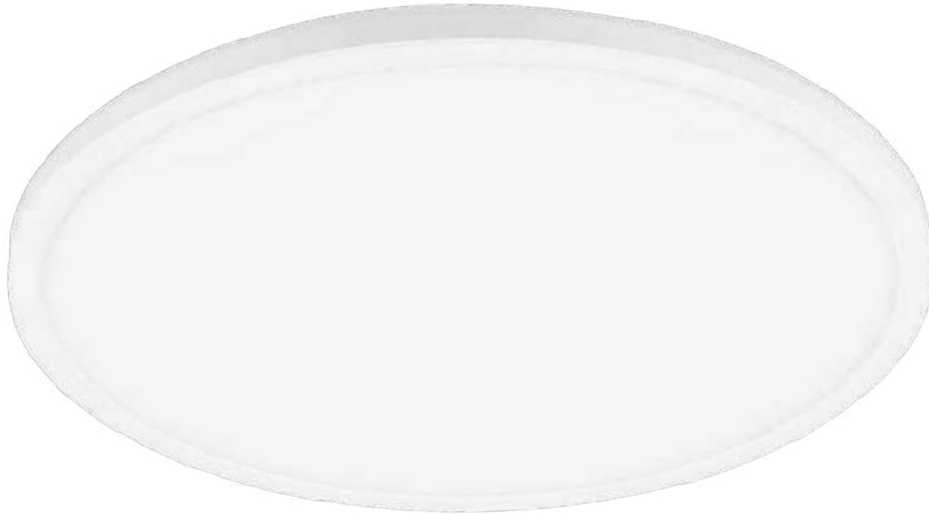



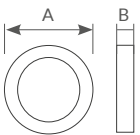

SUPERFICIE



Interior Plafones

19.5W 22W



-  4000K
-  6000K
-  120°
-  10.000
-  ≥80Ra
-  35.000h.
-  IP20
-  220-240V
-  50/60Hz

Plafón techo de LED

Forma: **redonda**. LED driver incluido. Material: **plástico**. Color: blanco. Uso interior.
Efecto luz indirecta sobre el techo gracias a la parte transparente superior.





Referencia	Con difusor / Luminaria	Sin difusor / Fuente de luz (360°)	Luz	Dimensión (AxB)	Embalaje
203605037	19.5W / 1800Lm	17.5W / 2200Lm	 4000K	Ø293x28.5mm	6
203605038	19.5W / 1800Lm	17.5W / 2200Lm	 6000K	Ø293x28.5mm	6
203605039	22W / 2500Lm	21W / 3000Lm	 4000K	Ø420x28.5mm	6
203605040	22W / 2500Lm	21W / 3000Lm	 6000K	Ø420x28.5mm	6

Simola
SUPERFICIE

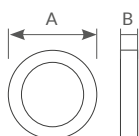

46W



-  4000K
-  120°
-  25.000
-  PF≥0.9
-  ≥80Ra
-  30.000h.
-  IP20
-  220V
-  50Hz





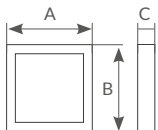

Plafón techo redondo LED

Forma: **redonda**. LED driver incluido. Material: **hierro y acrílico**. Uso interior.

Referencia	Con difusor / Luminaria	Sin difusor / Fuente de luz (360°)	Luz	Color	Dimensión (AxB)	Embalaje
203605077	46W / 3306Lm	46W / 6000Lm	● 4000K	○ Blanco	Ø610x85mm	1
203605078	46W / 3306Lm	46W / 6000Lm	● 4000K	● Gris	Ø610x85mm	1
203615001	Recambio driver para plafón Simola ref. 203605077 - 78 - 79					

Simola
SUPERFICIE



-  4000K
-  120°
-  25.000
-  PF ≥ 0.9
-  ≥ 80Ra
-  30.000h.
-  IP20
-  220V
-  Hz

Plafón techo cuadrado LED

Forma: **cuadrada**. LED driver incluido. Material: **hierro y acrílico**. Uso interior.

Referencia	Con difusor / Luminaria	Sin difusor / Fuente de luz (360°)	Luz	Color	Dimensión (AxB)	Embalaje
203605079	51W/3113Lm	51W/5724Lm	 4000K	 Blanco	625x625x85mm	1
203615001	Recambio driver para plafón Simola ref. 203605077 - 78 - 79					

Kataja
SUPERFICIE



32W

65W

82W



65W



65W

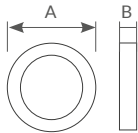

4000K



120°



25.000



PF ≥ 0.9



≥ 80Ra



30.000h.



IP20



220V



50Hz

Plafón techo redondo LED

Forma: **redonda**. LED driver incluido. Material: **hierro y acrílico** (blanco y negro), **aluminio y acrílico** (dorado). Uso interior.

Referencia	Con difusor / Luminaria	Sin difusor / Fuente de luz (360°)	Luz	Color	Dimensión (AxB)	Embalaje
203605080	32W / 2355Lm	32W / 3564Lm	● 4000K	○ Blanco	Ø400x60mm	1
203605081	65W / 4817Lm	65W / 7344Lm	● 4000K	○ Blanco	Ø600x60mm	1
203605082	65W / 4817Lm	65W / 7344Lm	● 4000K	● Negro	Ø600x60mm	1
203605083	65W / 4817Lm	65W / 7344Lm	● 4000K	● Dorado	Ø600x60mm	1
203605084	82W / 6948Lm	82W / 9202Lm	● 4000K	○ Blanco	Ø800x60mm	1
203615002	Recambio driver para plafón Kataja ref. 203605080 - 81 - 82 - 83					
203615003	Recambio driver para plafón Kataja ref. 203605084					

Peranka

SUPERFICIE

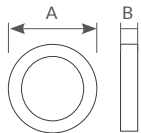

- 4000K
- 120°
- 25.000
- PF ≥ 0.9
- ≥ 80Ra
- 30.000h.
- IP20
- 220V
- 50Hz

Plafón techo **redondo LED**

Forma: **redonda**. LED driver incluido. Material: **aluminio, metal y acrílico**. Uso interior.

Referencia	Con difusor / Luminaria	Sin difusor / Fuente de luz (360°)	Luz	Color	Dimensión (AxB)	Emb.
203605085	42W / 2250Lm	42W / 4708Lm	● 4000K	○ Blanco + Efecto madera	Ø450x110mm	1
203605086	42W / 2250Lm	42W / 4708Lm	● 4000K	● Negro + Efecto madera	Ø450x110mm	1
203605087	65W / 3446Lm	32W / 7208Lm	● 4000K	○ Blanco + Efecto madera	Ø600x110mm	1
203605088	65W / 3446Lm	32W / 7208Lm	● 4000K	● Negro + Efecto madera	Ø600x110mm	1
203615004	Recambio driver para plafón Peranka ref. 203605085 - 86					
203615005	Recambio driver para plafón Peranka ref. 203605087 - 88					

Austra

SUPERFICIE

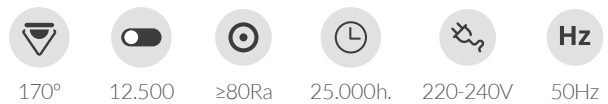
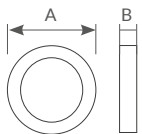
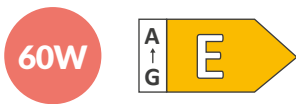

Plafón techo LED regulable

LED driver incluido. Material: **plástico**. Color: blanco. Uso interior.

Regulable en intensidad. Con mando a distancia (3 x AAA incl.).

Regulable en temperatura de color: 3000K / 4000K / 6500K o de forma gradual.

Con **memoria** del último estado de color.

Referencia	Con difusor / Luminaria	Sin difusor / Fuente de luz (360°)	Luz	Dimensión (AxB)	Embalaje
203605059	60W / 5100Lm (3000K) 60W / 5700Lm (4000K) 60W / 5100Lm (6500K)	60W / 6650Lm (4000K)	CCT	Ø500x80mm	5

Bogen
SUPERFICIE

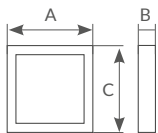

3000K



4200K



6000K



170°



12.500



≥80Ra



25.000h.



IP20



220-240V



50Hz

Plafón techo de LED

Forma: **cuadrada**. LED driver incluido. Material: **plástico**. **PF: 0.9**. Color: blanco. Uso interior.

Referencia	Con difusor / Luminaria (360°)	Sin difusor / Fuente de luz (360°)	Luz	Dimensión (AxB)	Embalaje
203605050	20W / 1600Lm	20W / 2050Lm	● 3000K	280x280x65mm	10
203605051	20W / 1600Lm	20W / 2050Lm	● 4000K	280x280x65mm	10
203605052	20W / 1600Lm	20W / 2050Lm	● 6500K	280x280x65mm	10
203605053	32W / 2560Lm	32W / 3380Lm	● 3000K	330x330x65mm	10
203605054	32W / 2560Lm	32W / 3380Lm	● 4000K	330x330x65mm	10
203605055	32W / 2560Lm	32W / 3380Lm	● 6500K	330x330x65mm	10
203605056	42W / 3570Lm	42W / 4490Lm	● 3000K	430x430x65mm	10
203605057	42W / 3570Lm	42W / 4490Lm	● 4000K	430x430x65mm	10
203605058	42W / 3570Lm	42W / 4490Lm	● 6500K	430x430x65mm	10

Kigoma

PLAFÓN TECHO

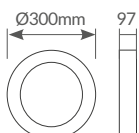

IP20



220-240V



50/60Hz

Plafón techo con sensor

Forma: **redonda**. Material: **PC**. Color: blanco. Uso interior.

Tiempo regulable: 10seg. \pm 3seg. a 3min \pm 3seg. **Máx. distancia detección:** 6M.

Luz ambiental: <3-2000lux (regulable). **Temperatura de funcionamiento:** -20°C+40°C.

Altura instalación: 2.2-4M. **Consumo stand-by:** 0.5W. Bombillas no incluidas.

Referencia	Potencia	Casquillo	Color	Embalaje
203610009	Máx. 2x25W	2xE27	○ Blanco	5

Bagori
SUPERFICIE



16W

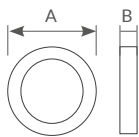

3000K



6000K



120°



20.000



≥80Ra



30.000h.



IP20



110-240V



50/60Hz

Plafón techo LED + sensor movimiento

Forma: **redonda**. LED driver incluido. Material: **plástico**. Color: blanco. Uso interior.
Tiempo regulable: 10seg. ± 3seg. a 5min ± 3seg. **Máx. distancia detección:** 9M (radio). **Luz ambiental:** 3-2000lux (regulable).
Temperatura de funcionamiento: -20°C+40°C. **Altura instalación:** 2.2-4M. **Consumo stand-by:** 0.45W.

Referencia	Con difusor / Luminaria	Sin difusor / Fuente de luz (360°)	Luz	Dimensión (Ax B)	Embalaje
203610002	16W / 1150Lm	15W / 1800Lm	● 3000K	Ø290x60mm	10
203610003	16W / 1150Lm	15W / 1800Lm	● 6000K	Ø290x60mm	10

Bamil
SERIE



A



B

* Bombillas no incluidas.

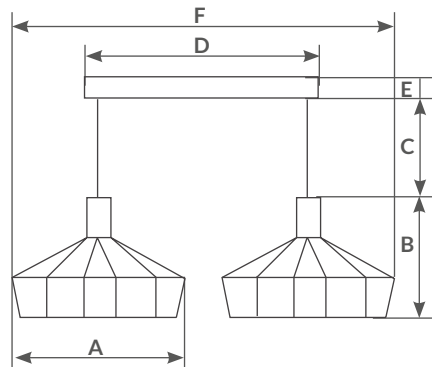
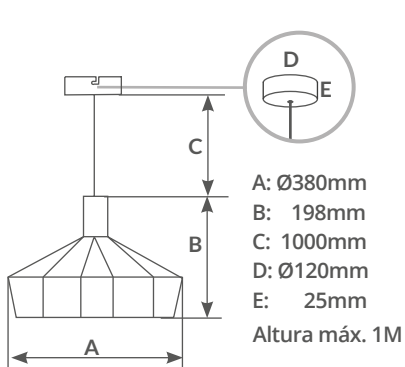

Incluye kit para colgar

Lámparas colgantes



IP20



220-240V



50Hz

Altura regulable. Incluye accesorios para colgar.

Referencia	Artículo	Tipo	Potencia	Casquillo	Color	Material	Embalaje
204400025	A	Simple	Máx. 40W	E27	● Negro	Metal	1
204400026	B	Doble	Máx. 40W	E27	● Negro	Metal	1



Interior Lámparas colgantes

Industrial LÁMPARA TECHO

Diamond LÁMPARA TECHO



A



B

* Bombillas no incluidas.

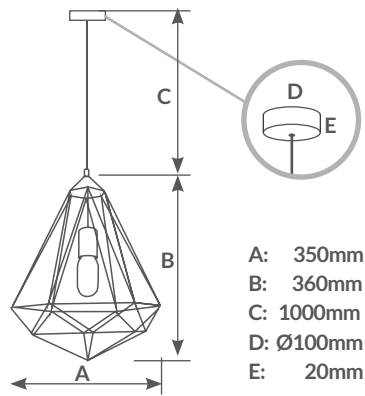
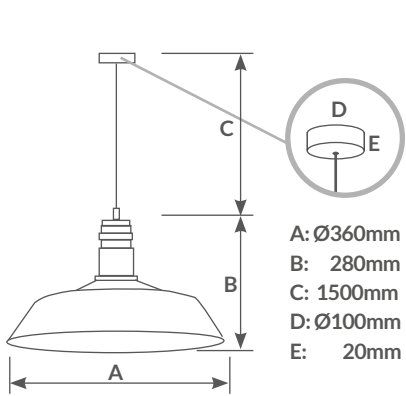

Altura regulable
Altura máx. 1M / 1.5M



Incluye
kit para colgar

Lámparas colgantes



IP20



220-240V



50/60Hz

Incluye accesorios para colgar.

Referencia	Artículo	Potencia	Casquillo	Color	Material	Interior	Cable	Embalaje
000705245	A	Máx. 60W	E27	● Negro	Metal	Blanco	1.5M	1
000705242	B	Máx. 60W	E27	● Negro	Metal	1	1M	1

Jaula

LÁMPARA TECHO

Hub

LÁMPARA TECHO



C



D

* Bombillas no incluidas.

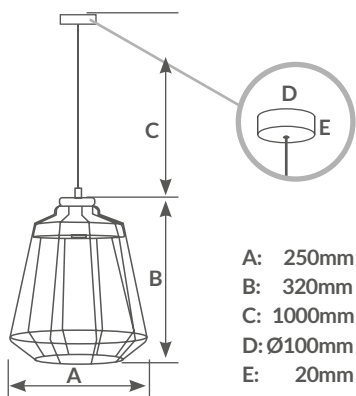

A: 250mm
B: 320mm
C: 1000mm
D: Ø100mm
E: 20mm

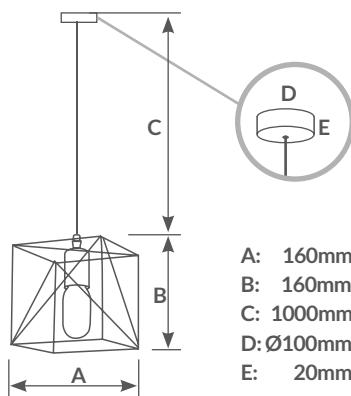

A: 160mm
B: 160mm
C: 1000mm
D: Ø100mm
E: 20mm



Altura regulable
Altura máx. 1M



Incluye
kit para colgar

Lámparas colgantes



IP20



220-240V



Hz

50/60Hz

Incluye accesorios para colgar.

Referencia	Artículo	Potencia	Casquillo	Color	Material	Embalaje
000705241	C	Máx. 60W	E27	● Negro	Metal + Madera	1
000705240	D	Máx. 60W	E27	● Negro	Metal	1

Fundi
SERIE



Interior Lámparas colgantes



A



B

* Bombillas no incluidas.

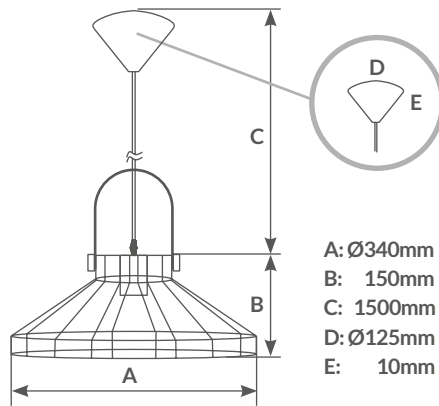
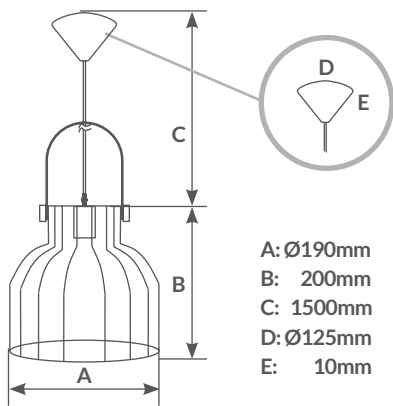

Altura regulable
Altura máx. 1.5M



Incluye
kit para colgar

Lámparas colgantes



IP20



230V



50Hz

Cable: 0.8M. Incluye accesorios para colgar.

Referencia	Artículo	Potencia	Casquillo	Color	Material	Embalaje
204400016	A	Máx. 40W	E27	● Negro + ● Haya	Metal	1
204400017	B	Máx. 40W	E27	● Negro + ● Haya	Metal	1

Fundi
SERIE



C



D

* Bombillas no incluidas.

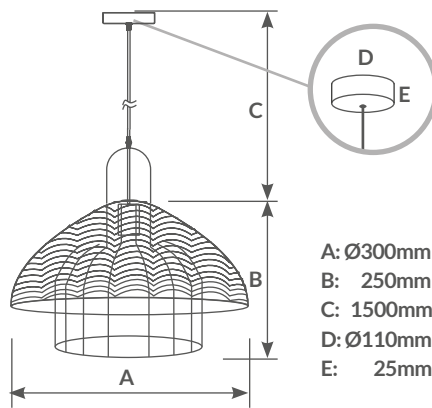
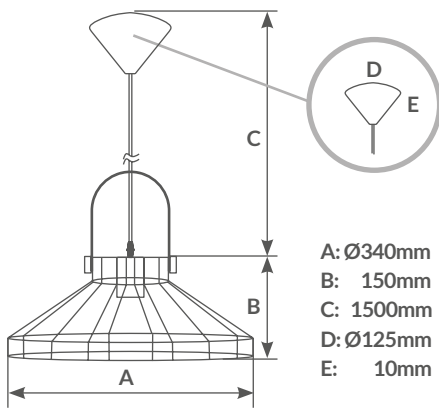

Altura regulable
Altura máx. 1.5M



Incluye
kit para colgar

Lámparas colgantes



IP20



230V



50Hz

Cable: 0.8M. Incluye accesorios para colgar.

Referencia	Artículo	Potencia	Casquillo	Color	Material	Embalaje
204400018	C	Máx. 40W	E27	● Negro + ● Haya	Metal	1
204400019	D	Máx. 40W	E27	● Negro + ● Haya	Metal	1

Kaliab

SERIE



* Bombillas no incluidas.

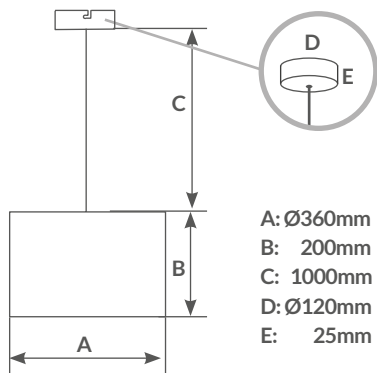

Altura regulable
Altura máx. 1M



Incluye
kit para colgar

Lámparas colgantes



IP20



220-240V



50Hz

Cable: 1M. Incluye accesorios para colgar.

Referencia	Potencia	Casquillo	Color	Material	Embalaje
204400029	Máx. 40W	E27	● Gris	Tela + Metal	1
204400030	Máx. 40W	E27	○ Blanco	Tela + Metal	1
204400031	Máx. 40W	E27	● Azul	Tela + Metal	1
204400032	Máx. 40W	E27	● Verde	Tela + Metal	1

Batwe
SERIE

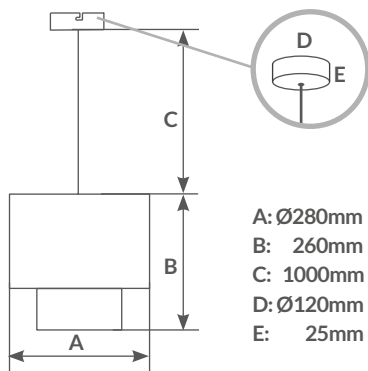

Altura regulable
Altura máx. 1M



Incluye
kit para colgar

* Bombillas no incluidas.

Interior Lámparas colgantes

Lámparas colgantes



IP20



220-240V



50Hz

Cable: 1M. Incluye accesorios para colgar.

Referencia	Potencia	Casquillo	Color	Material	Embalaje
204400033	Máx. 40W	E27	● Gris / Blanco	Tela + Metal	1
204400034	Máx. 40W	E27	○ Blanco	Tela + Metal	1



Sompara

SERIE



* Bombillas no incluidas.

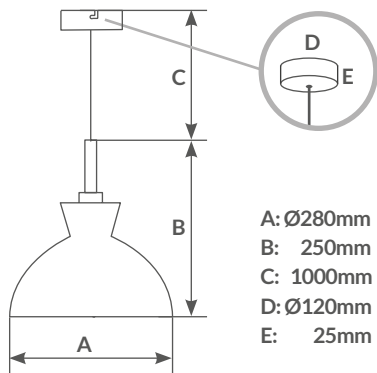

Altura regulable
Altura máx. 1M



Incluye
kit para colgar

Interior Lámparas colgantes

Lámparas colgantes



IP20



220-240V



50Hz

Cable: 1M. Incluye accesorios para colgar.

Referencia	Potencia	Casquillo	Color	Material	Embalaje
204400035	Máx. 40W	E27	● Negro	Metal + Madera	1
204400036	Máx. 40W	E27	○ Blanco	Metal + Madera	1
204400037	Máx. 40W	E27	● Gris	Metal + Madera	1
204400038	Máx. 40W	E27	● Verde	Metal + Madera	1
204400039	Máx. 40W	E27	● Amarillo	Metal + Madera	1
204400040	Máx. 40W	E27	● Rosa	Metal + Madera	1



Barum

LÁMPARA TECHO



* Bombillas no incluidas.

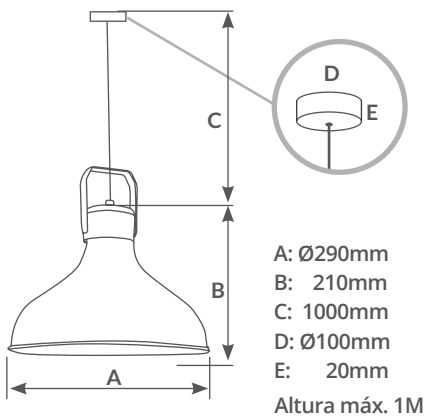

Altura regulable
 Altura máx. 1.5M



Incluye
 kit para colgar

Lámparas colgantes

IP20 230V 50Hz

Altura regulable. Incluye accesorios para colgar.

Referencia	Potencia	Casquillo	Color	Material	Interior	Embalaje
000705252	Máx. 60W	E27	● Cobre	Metal	Blanco	1

Beirut
LÁMPARA



Plástico

A

Origin
LÁMPARA



Aluminio

B

String
LÁMPARA



Aluminio
Con cadena
ON/OFF

C

* Bombillas no incluidas.

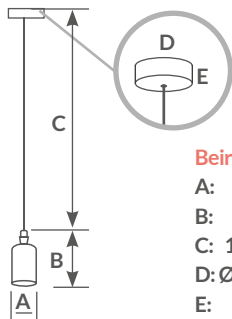

Beirut	Origin	String
A: Ø42mm	A: Ø42mm	A: Ø42mm
B: 62mm	B: 62mm	B: 81mm
C: 1000mm	C: 1000mm	C: 1000mm
D: Ø100mm	D: Ø100mm	D: Ø100mm
E: 20mm	E: 20mm	E: 20mm



Altura regulable
Altura máx. 1M



Incluye
kit para colgar

Lámparas colgantes



IP20



220-240V



50/60Hz

Cable: 1M. Incluye accesorios para colgar.

Referencia	Artículo	Potencia	Casquillo	Color	Material	Embalaje
000704712	A	Máx. 60W	E27	● Negro	Plástico	20
000705238	B	Máx. 60W	E27	● Oro Viejo	Aluminio	20
000705239	C	Máx. 60W	E27	● Oro Viejo	Aluminio	20



Yaren
LÁMPARA



A

Sedona
LÁMPARA



B

Nowra
LÁMPARA



C

* Bombillas no incluidas.

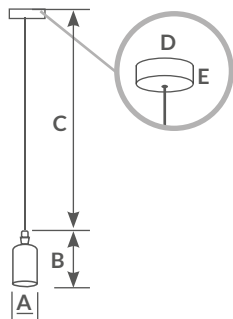

Yaren
A: Ø48mm
B: 66mm
C: 1000mm
D: Ø100mm
E: 20mm

Sedona
A: Ø48mm
B: 76mm
C: 1000mm
D: Ø100mm
E: 20mm

Nowra
A: Ø48mm
B: 76mm
C: 1000mm
D: Ø100mm
E: 20mm



Altura regulable
Altura máx. 1M



Incluye
kit para colgar

Lámparas colgantes



IP20



220-240V



50/60Hz

Cable: 1M. Incluye accesorios para colgar.

Referencia	Artículo	Potencia	Casquillo	Color	Material	Embalaje
000704714	A	Máx. 60W	E27	● Dorado	Latón	50
000704715	B	Máx. 60W	E27	● Dorado	Latón	50
000705237	C	Máx. 60W	E27	● Cobre	Aluminio	50

Cuval
LÁMPARA



A



B

Interior Lámparas colgantes



Altura regulable
Altura máx. 1M



IP20



250V



50Hz

Lámparas colgantes

Cable PVC 1M (2x0.75mm).

Referencia	Artículo	Potencia	Casquillo	Color	Embalaje
101550001	A	Máx. 60W	E27	○ Blanco	20/100
101550002	B	Máx. 60W	E27	● Negro	20/100

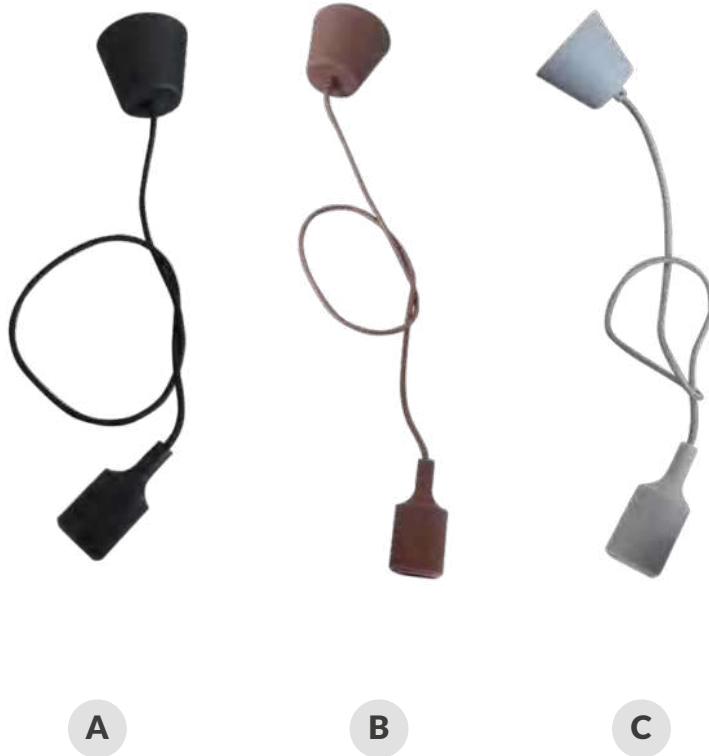

Altura regulable
Altura máx. 1M



Incluye
kit para colgar



IP20



220-240V



50/60Hz

Lámparas colgantes

Cable textil: 1M. Material: **silicona**. Incluye accesorios para colgar.

Referencia	Artículo	Potencia	Casquillo	Color	Embalaje
000702180	A	Máx. 60W	E27	● Negro	50
000702181	B	Máx. 60W	E27	● Marrón	50
000702182	C	Máx. 60W	E27	● Gris	50

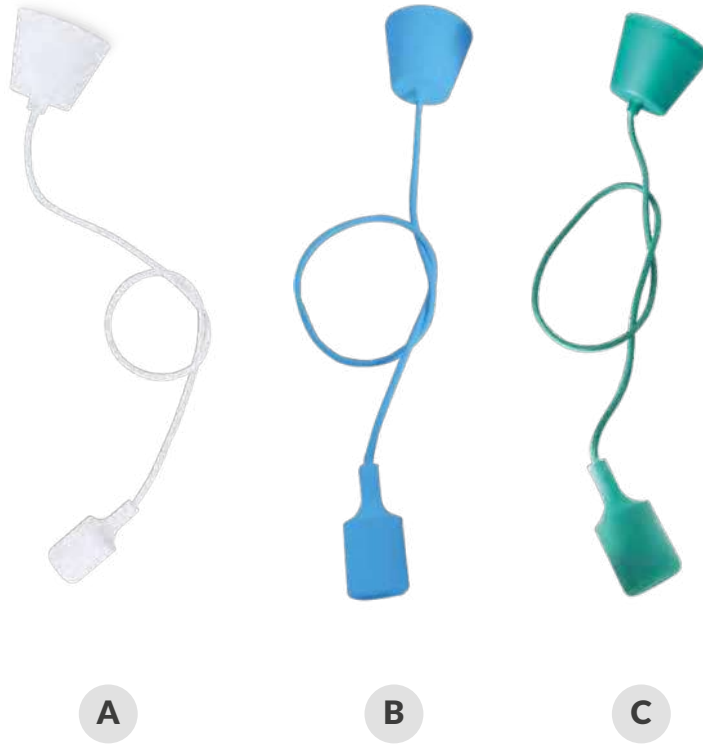

Altura regulable
Altura máx. 1M



Incluye
kit para colgar



IP20



220-240V



50/60Hz

Lámparas colgantes

Cable textil: 1M. Material: **silicona**. Incluye accesorios para colgar.

Referencia	Artículo	Potencia	Casquillo	Color	Embalaje
000703499	A	Máx. 60W	E27	○ Blanco	50
000702183	B	Máx. 60W	E27	● Azul	50
000702184	C	Máx. 60W	E27	● Turquesa	50



A



B



C



D



E



Altura regulable
Altura máx. 1M



Incluye
kit para colgar



IP20



220-240V

Hz

50/60Hz

Lámparas colgantes

Cable textil: 1M. Material: **silicona**. Incluye accesorios para colgar.

Referencia	Artículo	Potencia	Casquillo	Color	Embalaje
000702185	A	Máx. 60W	E27	Verde	50
000702188	B	Máx. 60W	E27	Violeta	50
000702186	C	Máx. 60W	E27	Amarillo	50
000702187	D	Máx. 60W	E27	Naranja	50
000702189	E	Máx. 60W	E27	Rojo	50



Langadu

SERIE

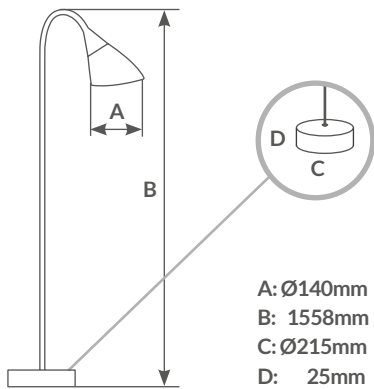
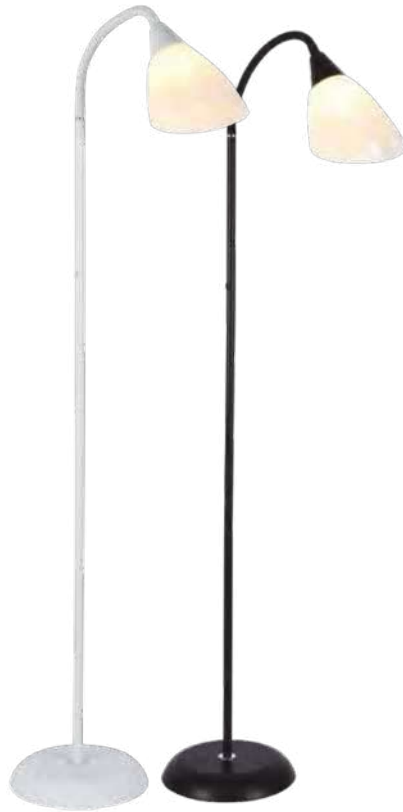

* Bombillas no incluidas.

Interior Lámparas de pie

Lámparas de pie



IP20



220-240V



Hz

50Hz

Cable: 1M. Con interruptor On/Off.

Referencia	Potencia	Casquillo	Color	Material	Embalaje
204400041	Máx. 40W	E27	○ Blanco	Metal + Plástico	1
204400042	Máx. 40W	E27	● Negro	Metal + Plástico	1

Nawis

SERIE

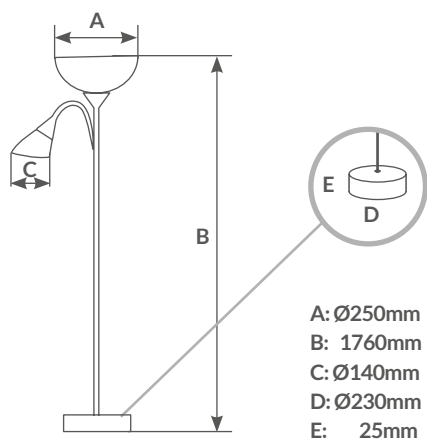

* Bombillas no incluidas.

Interior Lámparas de pie

Lámparas de pie



IP20



220-240V



Hz

50Hz

Cable: 1.5M. Con interruptor On/Off. Interruptores independientes.

Referencia	Potencia	Casquillo	Color	Material	Embalaje
204400045	Máx. 40W	E27 + E14	○ Blanco	Metal + Plástico	1
204400043	Máx. 40W	E27 + E14	● Negro	Metal + Plástico	1



Gohira
SERIE

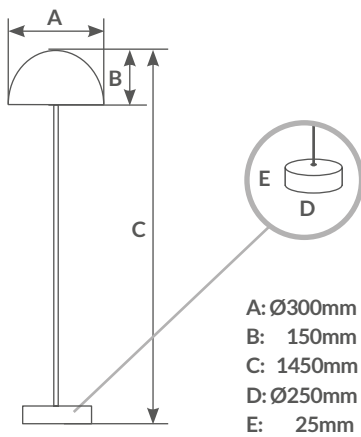

* Bombillas no incluidas.

Interior Lámparas de pie

Lámparas de pie



IP20



220-240V



50Hz

Cable: 1.8M. Con interruptor On/Off.

Referencia	Potencia	Casquillo	Color	Material	Embalaje
204400044	Máx. 40W	E27	● Antracita	Metal	1



A Redondo / Blanco



B Redondo / Níquel



C Semicircular / Blanco



D Semicircular / Níquel

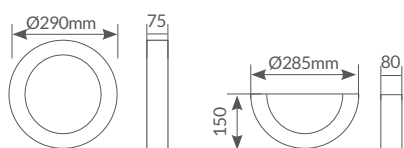

Apliques de pared



IP20



220-240V



50Hz

Uso interior.

Referencia	Artículo	Forma	Potencia	Casquillo	Color	Embalaje
000701936	A	Redonda	Máx. 60W	E27	○ Blanco	8
000701938	B	Redonda	Máx. 60W	E27	● Níquel Satín	8
000701937	C	Semicircular	Máx. 60W	E27	○ Blanco	12
000701939	D	Semicircular	Máx. 60W	E27	● Níquel Satín	12



A



B

8LED
COMPATIBLE

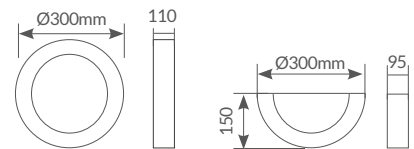

IP20



220-240V



50/60Hz

Apliques de pared

Uso interior.

Referencia	Artículo	Forma	Potencia	Casquillo	Color	Embalaje
000701994	A	Redonda	Máx. 60W	E27	○ Blanco	8
000701995	B	Semicircular	Máx. 60W	E27	○ Blanco	12

Selna
SERIE

8LED
COMPATIBLE



A Simple



B Doble

* Bombilla no incluida.

Interior Focos pared

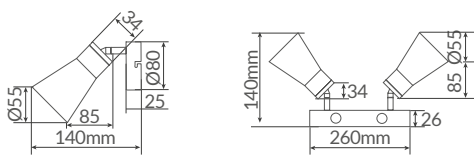

Aplicador de pared **con interruptor**



IP20



220-240V



50/60Hz

Color: blanco mate. Material: **metal**. Bombilla no incluida. **Brazo articulado**. Uso interior.

Referencia	Artículo	Tipo	Potencia	Casquillo	Embalaje
200000001	A	Simple	Máx. 50W	GU10	20
200000002	B	Doble	Máx. 50W	GU10	20

Kegla
SERIE

8LED
COMPATIBLE



A Simple



B Doble lineal



C Triple circular



D Triple espiral



E Cuádruple lineal

* Bombilla no incluida.

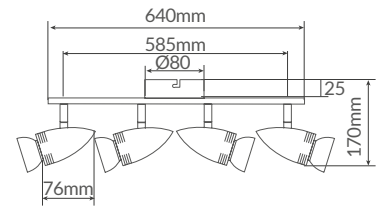
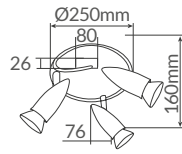
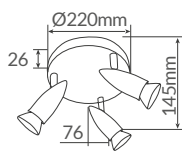
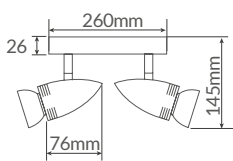
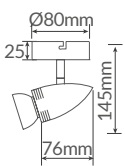

IP20



220-240V



50/60Hz

Focos de techo

Color: níquel satín. Material: metal. Bombilla no incluida. Brazo articulado. Uso interior.

Referencia	Artículo	Tipo	Potencia	Casquillo	Embalaje
202000025	A	Simple	Máx. 50W	GU10	20
202000026	B	Doble lineal	Máx. 50W	GU10	20
202000027	C	Triple circular	Máx. 50W	GU10	12
202000028	D	Triple espiral	Máx. 50W	GU10	12
202000029	E	Cuádruple lineal	Máx. 50W	GU10	8

Kaitola
SERIE

8LED
COMPATIBLE



A Simple

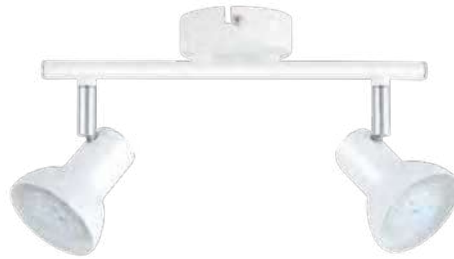

B Doble lineal



C Triple lineal



D Cuádruple lineal

* Bombilla no incluida.

Interior Focos techo

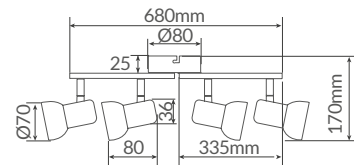
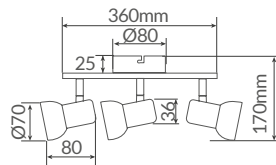
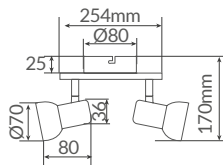
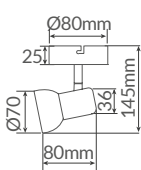

Focos de techo



IP20



220-240V



50/60Hz

Color: blanco mate. Material: **metal**. Bombilla no incluida. **Brazo articulado**. Uso interior.

Referencia	Artículo	Tipo	Potencia	Casquillo	Embalaje
202000033	A	Simple	Máx. 50W	GU10	20
202000034	B	Doble lineal	Máx. 50W	GU10	12
202000035	C	Triple lineal	Máx. 50W	GU10	8
202000036	D	Cuádruple lineal	Máx. 50W	GU10	6

Kaitola
SERIE

LED
COMPATIBLE



A Simple



B Doble lineal



C Triple lineal



D Cuádruple lineal

* Bombilla no incluida.

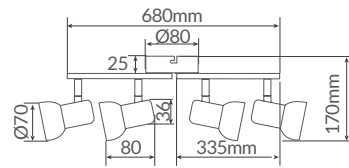
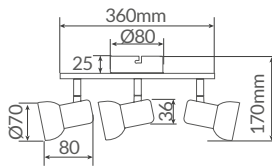
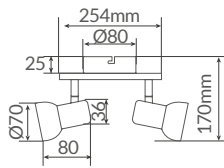
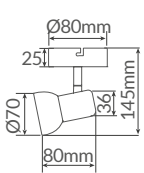

Focos de techo



IP20



220-240V



50/60Hz

Color: negro mate. Material: **metal**. Bombilla no incluida. **Brazo articulado**. Uso interior.

Referencia	Artículo	Tipo	Potencia	Casquillo	Embalaje
202000037	A	Simple	Máx. 50W	GU10	20
202000038	B	Doble lineal	Máx. 50W	GU10	12
202000039	C	Triple lineal	Máx. 50W	GU10	8
202000040	D	Cuádruple lineal	Máx. 50W	GU10	6



A Simple



B Doble lineal

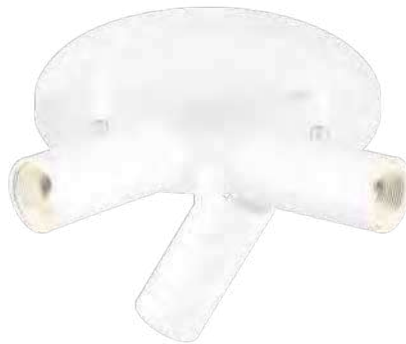

C Triple circular

* Bombilla no incluida.

Interior Focos techo

8LED
COMPATIBLE

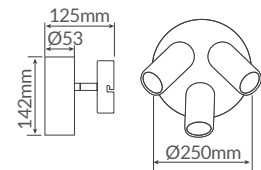
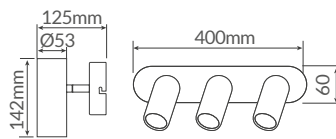
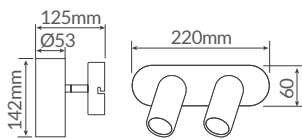
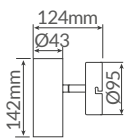

IP20



220-240V



50Hz

Focos de techo

Color: blanco mate. Material: **aluminio**. Bombilla no incluida. **Brazo articulado**. Uso interior.

Referencia	Artículo	Tipo	Potencia	Casquillo	Embalaje
000705200	A	Simple	Máx. 60W	GU10	20
000705201	B	Doble lineal	Máx. 60W	GU10	10
000705202	C	Triple circular	Máx. 60W	GU10	4



A Simple



B Triple lineal

* Bombilla no incluida.

8LED
COMPATIBLE

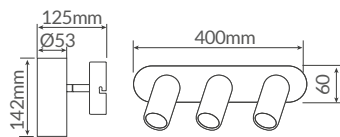
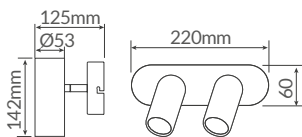

IP20



220-240V



50Hz

Focos de techo

Color: cobre mate. Material: **aluminio**. Bombilla no incluida. **Brazo articulado**. Uso interior.

Referencia	Artículo	Tipo	Potencia	Casquillo	Embalaje
202000001	A	Simple	Máx. 60W	GU10	20
202000003	B	Triple lineal	Máx. 60W	GU10	10



A Simple



B Doble lineal



C Triple lineal



D Cuádruple lineal

* Bombilla no incluida.

Interior Focos techo

8LED
COMPATIBLE

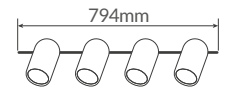
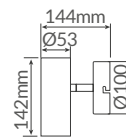
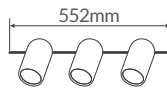
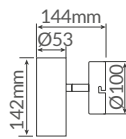
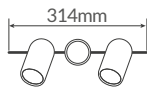
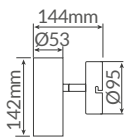
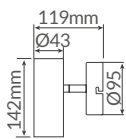

IP20



220-240V



50Hz

Focos de **techo**

Color: níquel satín. Material: **aluminio**. Bombilla no incluida. **Brazo articulado**. Uso interior.

Referencia	Artículo	Tipo	Potencia	Casquillo	Embalaje
000705203	A	Simple	Máx. 60W	GU10	20
000705204	B	Doble lineal	Máx. 60W	GU10	4
000705205	C	Triple lineal	Máx. 60W	GU10	4
000705206	D	Cuádruple lineal	Máx. 60W	GU10	4

Edina SERIE



A Simple



B Doble lineal



C Triple lineal



D Triple circular

* Bombilla no incluida.

8LED COMPATIBLE

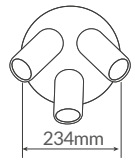
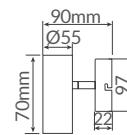
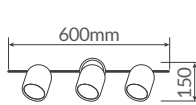
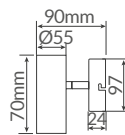
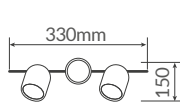
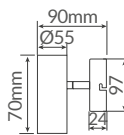
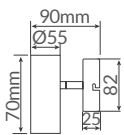

IP20



220-240V



50Hz

Focos de techo

Color: negro. Material: **hierro**. Bombilla no incluida. **Brazo articulado**. Portalámparas incluido. Uso interior.

Referencia	Artículo	Tipo	Potencia	Casquillo	Embalaje
001905356	A	Simple	Máx. 50W	GU10	36
001905358	B	Doble lineal	Máx. 50W	GU10	12
001905360	C	Triple lineal	Máx. 50W	GU10	12
001905362	D	Triple circular	Máx. 50W	GU10	12

Edina
SERIE



A Simple



B Doble lineal



C Triple lineal



D Triple circular

* Bombilla no incluida.

Interior Focos techo

LED
COMPATIBLE

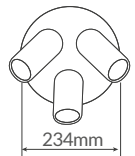
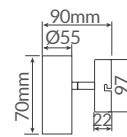
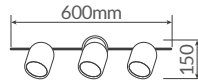
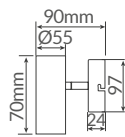
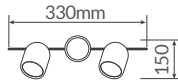
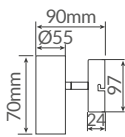
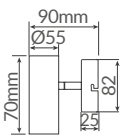

IP20



220-240V



50Hz

Focos de techo

Color: blanco. Material: **metal**. Bombilla no incluida. **Brazo articulado**. Portalámparas incluido. Uso interior.

Referencia	Artículo	Tipo	Potencia	Casquillo	Embalaje
001905355	A	Simple	Máx. 50W	GU10	36
001905357	B	Doble lineal	Máx. 50W	GU10	12
001905359	C	Triple lineal	Máx. 50W	GU10	12
001905361	D	Triple circular	Máx. 50W	GU10	12

Rintela

SERIE



A Simple



B Doble lineal

LED
COMPATIBLE

* Bombilla no incluida.



Instalación foco simple
en techo y pared



Instalación foco doble
en techo

Focos de techo



IP20



220-240V



50/60Hz

Material: **metal**, **base madera**. Bombilla no incluida. **Brazo articulado**. Portalámparas incluido. Uso interior.

Referencia	Artículo	Tipo	Color	Potencia	Casquillo	Embalaje
202000017	A	Simple	● Negro	Máx. 60W	GU10	50
202000018	A	Simple	○ Blanco	Máx. 60W	GU10	50
202000019	B	Doble lineal	● Negro	Máx. 60W	GU10	20
202000020	B	Doble lineal	○ Blanco	Máx. 60W	GU10	20

Guimara

SERIE

8LED
COMPATIBLE



A Simple



B Doble lineal



C Triple lineal



D Cuádruple lineal

* Bombilla no incluida.

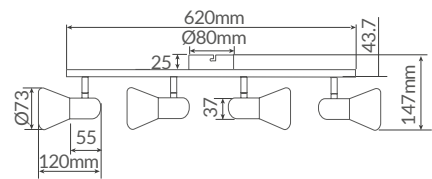
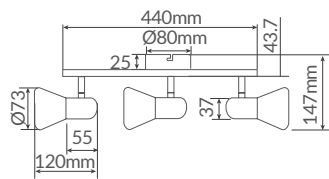
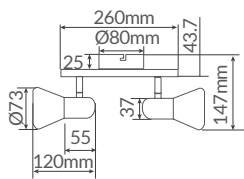
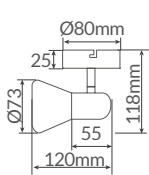

Focos de techo



IP20



220-240V



50/60Hz

Color: níquel satín. Material: **metal + cristal**. Bombilla no incluida. **Brazo articulado**. Uso interior.

Referencia	Artículo	Tipo	Potencia	Casquillo	Embalaje
202000041	A	Simple	Máx. 40W	E14	40
202000042	B	Doble lineal	Máx. 40W	E14	24
202000043	C	Triple lineal	Máx. 40W	E14	8
202000044	D	Cuádruple lineal	Máx. 40W	E14	8

Bhani
SERIE

LED
COMPATIBLE



A

Simple



B

Doble lineal



C

Triple lineal

* Bombilla no incluida.

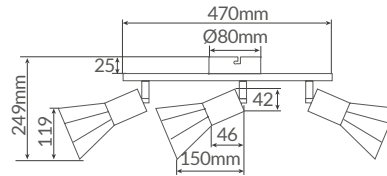
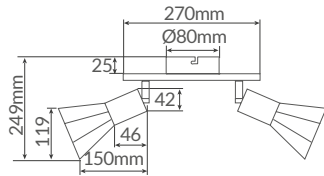
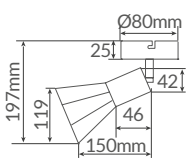

IP20



220-240V



50/60Hz

Focos de techo

Color: negro mate. Material: **metal**. Bombilla no incluida. **Brazo articulado**. Uso interior.

Referencia	Artículo	Tipo	Potencia	Casquillo	Embalaje
202000030	A	Simple	Máx. 40W	E27	20
202000031	B	Doble lineal	Máx. 40W	E27	8
202000032	C	Triple lineal	Máx. 40W	E27	8

Salmela

SERIE



A Simple



B Doble lineal

* Bombilla no incluida.

LED
COMPATIBLE



Instalación foco simple
en techo y pared



Instalación foco doble
en techo

Focos de techo



IP20



220-240V



50/60Hz

Material: **metal**. Bombilla no incluida. **Brazo articulado**. Portalámparas incluido. Uso interior.

Referencia	Artículo	Tipo	Color	Potencia	Casquillo	Embalaje
202000021	A	Simple	● Negro	Máx. 60W	E27	50
202000022	A	Simple	○ Blanco	Máx. 60W	E27	50
202000023	B	Doble lineal	● Negro	Máx. 60W	E27	20
202000024	B	Doble lineal	○ Blanco	Máx. 60W	E27	20

Sehay

SERIE



* Bombilla no incluida.

LED
COMPATIBLE

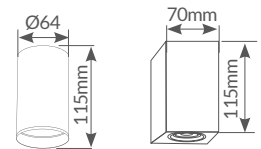

Foco redondo de techo



Instalación en techo. Color: blanco mate. Material: **aluminio.**
Para lámparas dicroicas. Bombilla no incluida. **Portalámparas GU10 incluido.**

Referencia	Artículo	Tipo	Potencia	Embalaje
20200004	A	Redondo	Máx. 10W	10/60
20200005	B	Cuadrado	Máx. 10W	10/60

Serkka

SERIE



Instalación en pared

Instalación en techo

8LED
COMPATIBLE

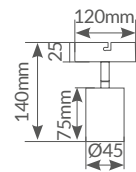
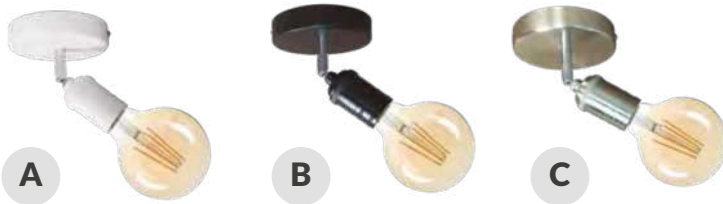

* Bombilla no incluida.

Focos de techo



IP20



220-240V



50/60Hz

Cabezal de **metal**. Bombilla no incluida. **Brazo articulado**. Portalámparas incluido. Uso interior.

Referencia	Artículo	Tipo	Color	Potencia	Casquillo	Embalaje
202000006	A	Simple	○ Blanco	Máx. 60W	E27	50
202000007	B	Simple	● Negro	Máx. 60W	E27	50
202000008	C	Simple	● Níquel Satín	Máx. 60W	E27	50

Kestila

SERIE



Instalación en pared

Instalación en techo

LED
COMPATIBLE



A



B



C



D

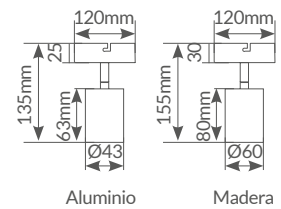

Aluminio

Madera

* Bombilla no incluida.



IP20



220-240V



50/60Hz

Focos de techo

Material: **metal** (202000009-10-11), **madera** (202000012).
Bombilla no incluida. **Brazo articulado**. Portalámparas incluido. Uso interior.

Referencia	Artículo	Tipo	Color	Potencia	Casquillo	Embalaje
202000009	A	Simple	○ Blanco	Máx. 60W	E27	50
202000010	B	Simple	● Negro	Máx. 60W	E27	50
202000011	C	Simple	● Níquel Satín	Máx. 60W	E27	50
202000012	D	Simple	● Madera	Máx. 60W	E27	50

Jokela
SERIE



Interior Focos techo

LED
COMPATIBLE

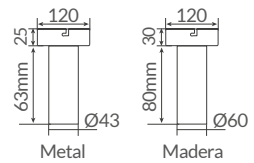

* Bombilla no incluida.



IP20



220-240V



50/60Hz

Focos de techo

Material: **metal** (202000013-14-15), **madera** (202000016). Bombilla no incluida.
Brazo articulado. Portalámparas incluido. Uso interior.

Referencia	Artículo	Tipo	Color	Potencia	Casquillo	Embalaje
202000013	A	Simple	○ Blanco	Máx. 60W	E27	50
202000014	B	Simple	● Negro	Máx. 60W	E27	50
202000015	C	Simple	● Níquel Satín	Máx. 60W	E27	50
202000016	D	Simple	● Madera	Máx. 60W	E27	50



8LED
COMPATIBLE

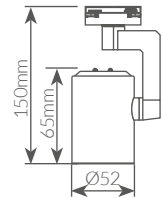

IP20



220-240V



50Hz

Foco carril monofásico

Tipo: **orientable**. Material: **plástico + metal**. Ideal para dicroicas. Bombilla no incluida. Uso interior.

Referencia	Potencia	Casquillo	Color	Embalaje
202205001	Máx. 20W	GU10	● Negro	50
202205002	Máx. 20W	GU10	○ Blanco	50



Interior Comercial

8LED
COMPATIBLE

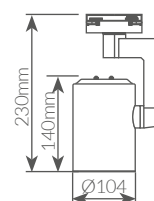

IP20



220-240V



50Hz

Foco carril **monofásico**

Tipo: **orientable**. Material: **plástico + metal**. Ideal para reflectoras R90. Bombilla no incluida. Uso interior.

Referencia	Potencia	Casquillo	Color	Embalaje
202205003	Máx. 30W	E27	● Negro	20
202205004	Máx. 30W	E27	○ Blanco	20



A



B



C



D

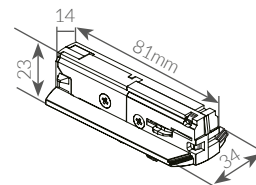
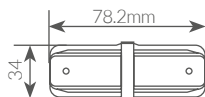
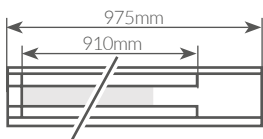

Accesorios para focos monofásicos



IP20



220-240V



50/60Hz

Para foco monofásico. Uso interior.

Referencia	Artículo	Descripción	Color	Material	Embalaje
202200001	A	Carril	● Negro	Aluminio	50
202200002	A	Carril	○ Blanco	Aluminio	50
202210001	B	Conector recto	● Negro	ABS + Hierro	100
202210002	B	Conector recto	○ Blanco	ABS + Hierro	100
202210003	C	Kit suspensión	● Negro	Hierro	100
202210004	C	Kit suspensión	○ Blanco	Hierro	100
202205005	D	Luminaria prensa estopa	● Negro	ABS + Hierro	250
202205006	D	Luminaria prensa estopa	○ Blanco	ABS + Hierro	250

Ubari

EMPOTRABLE



40W

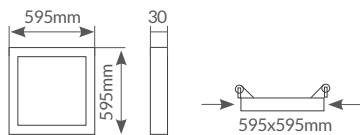
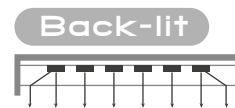

4200K

6000K

120°

100.000

≥80Ra

30.000h.

200-240V

50/60Hz

Panel empotrable LED

Forma: cuadrada. Tipo: empotrable. LED driver incluido. Material: aluminio + PS. Uso interior. IP20. IK05.

Referencia	Con difusor / Luminaria (360°)	Sin difusor / Fuente de luz (360°)	Luz	Color	Embalaje
203400012	40W / 4200Lm	36W / 4650Lm	● 4200K	○ Blanco	6
203400013	40W / 4200Lm	36W / 4650Lm	● 6000K	○ Blanco	6
203415002	Recambio driver 40W				

Interior Paneles LED

Sabha

EMPOTRABLE



Níquel Satin

Blanco

40W



Edge-lit

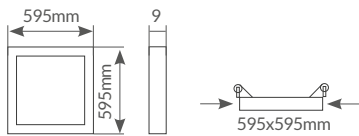
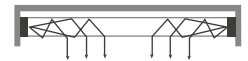

- 4200K
- 6000K
- 120°
- 100.000
- ≥80Ra
- 30.000h.
- 200-240V
- Hz

Panel empotrable ultrafino LED

Forma: **cuadrada**. LED driver incluido. Material: **aluminio + PS**. Uso interior.
 Posibilidades de instalación: **en techo sin separadores, para colgar y tipo downlight.**

Referencia	Con difusor / Luminaria (360°)	Sin difusor / Fuente de luz (360°)	Luz	Color	Embalaje
203400008	40W / 4000Lm	36W / 4650Lm	4200K	Blanco	6
203400009	40W / 4000Lm	36W / 4650Lm	6000K	Blanco	6
203400010	40W / 4000Lm	36W / 4650Lm	4200K	Níquel Satin	6
203400011	40W / 4000Lm	36W / 4650Lm	6000K	Níquel Satin	6
203415002	Recambio driver 40W				

Lubuko
EMPOTRABLE



UGR<19

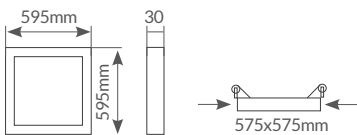
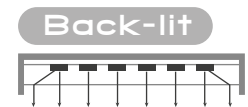

4200K

5000K

120°

100.000

≥80Ra

50.000h.

IP44

220-240V

50/60Hz

Panel empotrable LED

Forma: **cuadrada**. Tipo: **empotrable**. LED driver incluido. Material: **aluminio + PS**.
Sustituye a los paneles tradicionales. **IK05. PF 0.95. Se vende en pack de 2 unidades.**

Referencia	Con difusor / Luminaria (360°)	Sin difusor / Fuente de luz (360°)	Luz	Color	Embalaje
203400024	40W / 4800Lm	36W / 5200Lm	● 4200K	○ Blanco	4
203400025	40W / 4800Lm	36W / 5200Lm	● 5000K	○ Blanco	4
203415007	Recambio driver 40W				

Gilé

EMPOTRABLE

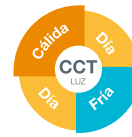

40W



UGR<19

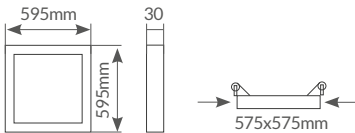
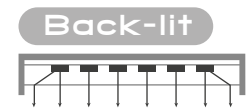

120°



100.000



≥80Ra



30.000h.



220-240V



50/60Hz

Panel empotrable LED

Forma: **cuadrada**. Tipo: **empotrable**. LED driver incluido. Material: **aluminio + PS**. Uso interior. IP20. **IK05. PF 0.95**. Cambio de temperatura a través del interruptor.

Referencia	Con difusor / Luminaria (360°)	Sin difusor / Fuente de luz (360°)	Luz	Color	Embalaje
203400026	40W / 3600Lm	36W / 4400Lm	3000-4000-6000K	○ Blanco	6
203415002	Recambio driver 40W				

Reteta
EMPOTRABLE



40W

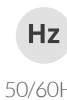
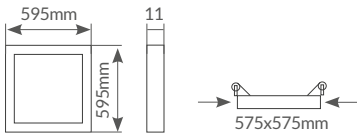

4200K

6000K

120°

100.000

≥80Ra

30.000h.

220-240V

50/60Hz

Marco empotrable panel LED

Forma: **cuadrada**. Tipo: **empotrable**. LED driver incluido. Material: **aluminio + PC**. Sustituye a los paneles tradicionales. Uso interior. IP20. **IK05. PF 0.95**.

Referencia	Con difusor / Luminaria (360°)	Sin difusor / Fuente de luz (360°)	Luz	Color	Embalaje
203400027	40W / 4000Lm	36W / 4400Lm	● 4200K	○ Blanco	10
203400028	40W / 4000Lm	36W / 4400Lm	● 6000K	○ Blanco	10
203415002	Recambio driver 40W				

Hassi

EMPOTRABLE



Níquel Satín

Blanco

Interior Paneles LED

40W

60W

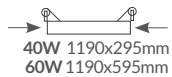
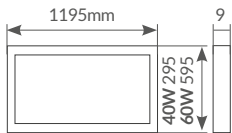
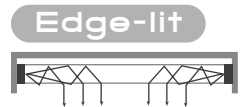

4200K



6000K



120°



100.000



≥80Ra



30.000h.



220-240V



50/60Hz

Panel empotrable rectangular LED

Forma: **rectangular**. LED driver incluido. Material: **aluminio + PS**. Uso interior.
 Posibilidades de instalación: **en techo sin separadores, para colgar y tipo downlight**.

Referencia	Con difusor / Luminaria (360°)	Sin difusor / Fuente de luz (360°)	Luz	Color	Embalaje
203400014	40W / 4000Lm	36W / 4550Lm	● 4200K	● Níquel Satín	5
203400015	40W / 4000Lm	36W / 4550Lm	● 6000K	● Níquel Satín	5
203400016	60W / 6000Lm	54W / 6600Lm	● 4200K	○ Blanco	5
203400017	60W / 6000Lm	54W / 6600Lm	● 6000K	○ Blanco	5
203415002	Recambio driver 40W				
203415001	Recambio driver 30W para paneles de 60W se utilizan 2 recambios (30W x 2)				

Luena
EMPOTRABLE



60W

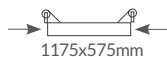
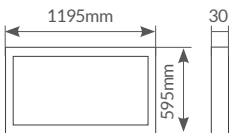
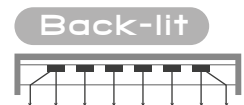

4200K



6000K



120°



100.000



≥80Ra



30.000h.



220-240V



50/60Hz

Panel empotrable LED

Forma: **rectangular**. Tipo: **empotrable**. LED driver incluido. Material: **aluminio + PS**. Uso interior. IP20. **IK05. PF 0.95**.

Referencia	Con difusor / Luminaria (360°)	Sin difusor / Fuente de luz (360°)	Luz	Color	Embalaje
203400022	60W / 6000Lm	54W / 6600Lm	● 4200K	○ Blanco	6
203400023	60W / 6000Lm	54W / 6600Lm	● 6000K	○ Blanco	6
203415001	Recambio driver 30W para paneles de 60W (30W x 2)				

Borma
SUPERFICIE



40W

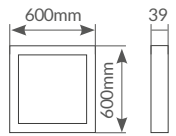
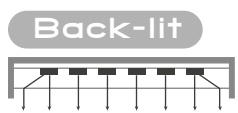

- 4200K
- 6000K
- 120°
- 100.000
- ≥80Ra
- 30.000h.
- IP20
- 220-240V
- 50/60Hz

Interior Paneles LED

Panel superficie LED

Forma: **cuadrada**. Tipo: **superficie**. LED driver incluido. Material: **aluminio + PS**.
Sustituye a los paneles tradicionales. Uso interior. **IK05. PF 0.95**.

Referencia	Con difusor / Luminaria (360°)	Sin difusor / Fuente de luz (360°)	Luz	Color	Embalaje
203405015	40W / 4200Lm	36W / 4650Lm	4200K	Blanco	6
203405016	40W / 4200Lm	36W / 4650Lm	6000K	Blanco	6
203405025	40W / 4200Lm	36W / 4650Lm	4200K	Negro	6
203405026	40W / 4200Lm	36W / 4650Lm	6000K	Negro	6
203405002	Recambio driver 40W				

Menia
SUPERFICIE

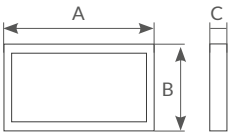

Interior Paneles LED

Panel rectangular superficie LED

Forma: **rectangular**. Tipo: **superficie**. LED driver incluido. Material: **aluminio**. Sustituye a los paneles tradicionales. Uso interior. **IK05**.

Referencia	Con difusor / Luminaria (360°)	Sin difusor / Fuente de luz (360°)	Luz	Color	Dimensión (AxBxC)	Embalaje
203405004	24W / 2160Lm	21.6W / 2630Lm	● 4200K	● Níquel Satín	600x300x38mm	5
203405006	24W / 2160Lm	21.6W / 2630Lm	● 6000K	● Níquel Satín	600x300x38mm	5
000704064	Recambio driver 24W					
203405008	36W / 3420Lm	32.4W / 3950Lm	● 4200K	● Níquel Satín	900x300x38mm	5
203405010	36W / 3420Lm	32.4W / 3950Lm	● 6000K	● Níquel Satín	900x300x38mm	5
000704066	Recambio driver 36W					
203405012	40W / 4000Lm	36W / 4450Lm	● 4200K	● Níquel Satín	1200x300x38mm	5
203405014	40W / 4000Lm	36W / 4450Lm	● 6000K	● Níquel Satín	1200x300x38mm	5
203415002	Recambio driver 40W					

Kisongo
SUPERFICIE

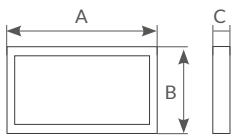
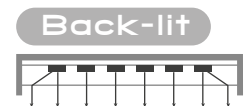

Interior Paneles LED

Panel rectangular superficie LED

Forma: **rectangular**. Tipo: **superficie**. LED driver incluido. Material: **aluminio + PS**.
Sustituye a los paneles tradicionales. Uso interior. **IK05. PF 0.95**.

Referencia	Con difusor / Luminaria (360°)	Sin difusor / Fuente de luz (360°)	Luz	Color	Dimensión (AxBxC)	Embalaje
203405017	24W / 2400Lm	21.6W / 2600Lm	● 4200K	○ Blanco	600x300x38mm	6
203405018	24W / 2400Lm	21.6W / 2600Lm	● 6000K	○ Blanco	600x300x38mm	6
203415004	Recambio driver 24W					
203405019	36W / 3600Lm	32.4W / 3900Lm	● 4200K	○ Blanco	900x300x38mm	6
203405020	36W / 3600Lm	32.4W / 3900Lm	● 6000K	○ Blanco	900x300x38mm	6
203415006	Recambio driver 36W					
203405021	40W / 4000Lm	36W / 4400Lm	● 4200K	○ Blanco	1200x300x38mm	6
203405022	40W / 4000Lm	36W / 4400Lm	● 6000K	○ Blanco	1200x300x38mm	6
203405002	Recambio driver 40W					
203405023	60W / 6000Lm	54W / 6600Lm	● 4200K	○ Blanco	1200x600x38mm	6
203405024	60W / 6000Lm	54W / 6600Lm	● 6000K	○ Blanco	1200x600x38mm	6
203415005	Recambio driver 30W para paneles de 60W (30W x 2)					

Kisongo

SUPERFICIE

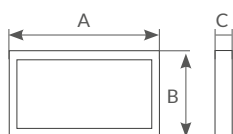

4200K



6000K



120°



100.000



≥80Ra



30.000h.



220-240V



50/60Hz

Panel rectangular superficie LED

Forma: **rectangular**. Tipo: **superficie**. LED driver incluido. Material: **aluminio + PS**.
Sustituye a los paneles tradicionales. Uso interior. **IK05. PF 0.95**.

Referencia	Con difusor / Luminaria (360°)	Sin difusor / Fuente de luz (360°)	Luz	Color	Dimensión (AxBxC)	Embalaje
203405027	24W / 2400Lm	21.6W / 2600Lm	● 4200K	● Negro	600x300x38mm	6
203405028	24W / 2400Lm	21.6W / 2600Lm	● 6000K	● Negro	600x300x38mm	6
203415004	Recambio driver 24W					
203405029	36W / 3600Lm	32.4W / 3900Lm	● 4200K	● Negro	900x300x38mm	6
203405030	36W / 3600Lm	32.4W / 3900Lm	● 6000K	● Negro	900x300x38mm	6
203415006	Recambio driver 36W					
203405031	40W / 4000Lm	36W / 4400Lm	● 4200K	● Negro	1200x300x38mm	6
203405032	40W / 4000Lm	36W / 4400Lm	● 6000K	● Negro	1200x300x38mm	6
203405002	Recambio driver 40W					
203405033	60W / 6000Lm	54W / 6600Lm	● 4200K	● Negro	1200x600x38mm	6
203405034	60W / 6000Lm	54W / 6600Lm	● 6000K	● Negro	1200x600x38mm	6
203415005	Recambio driver 30W para paneles de 60W (30W x 2)					



Set para superficie paneles LED

Para colgar paneles LED: Sabha. Uso interior.

Referencia	Dimensión	Color	Material	Embalaje
000704019	600x600x43mm	● Níquel Satín	Aluminio	1
000704020	600x600x43mm	○ Blanco	Aluminio	1



Set para superficie paneles LED

Para colgar paneles LED: Hassi. Uso interior.

Referencia	Dimensión	Color	Material	Embalaje
000704033	300x1200x43mm	● Níquel Satín	Aluminio	1
000703455	600x1200x43mm	○ Blanco	Aluminio	1



Set para colgar paneles LED

Para colgar paneles LED: Sabha y Hassi. Uso interior.

Referencia	Longitud	Embalaje
000702179	Máx. 1M	100



Montaje tipo downlight paneles LED

Para montar paneles LED tipo downlight: Sabha y Hassi. Uso interior.

Referencia	Unidades	Embalaje
000704014	Pack 4	1



Driver LIFUD regulable TRIAC para paneles LED

Para paneles LED: Sabha, Hassi, Luena, Gilé, Ubari, Reteta y Lubuko. Uso interior.

Referencia	Potencia	(V) salida	(V) entrada	Emb.
203410001	40W	33-40V	220-240V	1



Set para emergencias paneles LED

Para colgar paneles LED: Hassi. Uso interior. IP20.

Referencia	Potencia	Función	Voltaje	Emb.
000704042	42W	Emergencia	220-240V	25



Lokutu
REGLETA

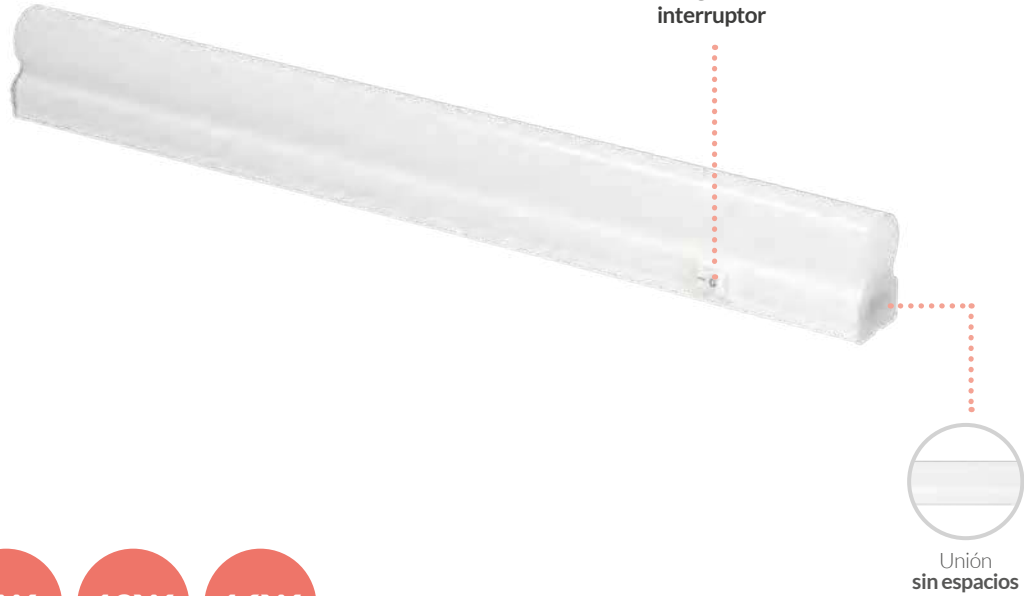

- 4W
- 8W
- 12W
- 16W

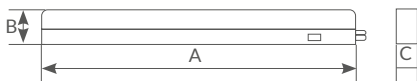

- 6500K
- 160°
- 10.000
- ≥80Ra
- 30.000h.
- 220V
- Hz

Regleta T5 LED

Con interruptor. **Interconexionables.** Cable 1.5M.
Possibilidad de unir hasta 10 regletas (203800050-51-52) y 8 regletas (203800053). Uso interior.

Referencia	Potencia	Lúmenes	Luz	Dimensión (AxBxC)	Embalaje
203800050	4W	400Lm	● 6500K	305x23x32mm	25
203800051	8W	790Lm	● 6500K	575x23x32mm	25
203800052	12W	1160Lm	● 6500K	875x23x32mm	25
203800053	16W	1600Lm	● 6500K	1179x23x32mm	25

Belo

REGLETA

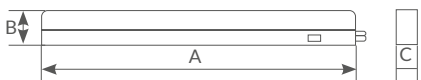
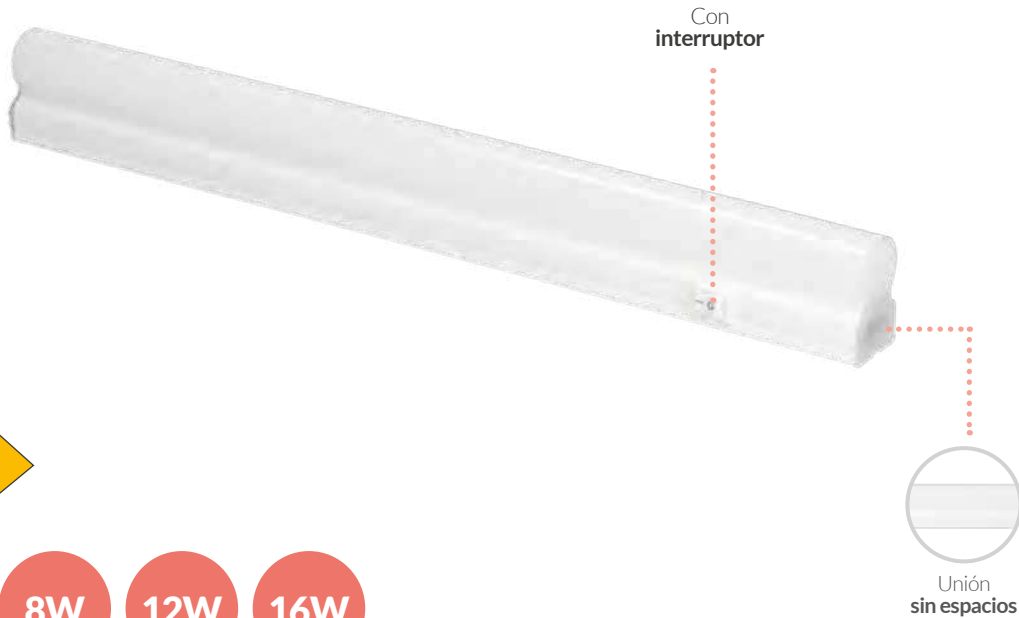

4000K



6500K



120°



10.000



≥80Ra



25.000h.



230V



50Hz

Regleta T5 LED

Con interruptor. **Interconexionables.** Cable 1.5M.
Posibilidad de unir hasta 10 regletas. Uso interior.

Referencia	Potencia	Lúmenes	Luz	Dimensión (AxBxC)	Embalaje
203800033	4W	380Lm	● 4000K	310x23x36mm	20
203800034	4W	380Lm	● 6500K	310x23x36mm	20
203800035	8W	830Lm	● 4000K	570x23x36mm	20
203800036	8W	830Lm	● 6500K	570x23x36mm	20
203800037	12W	1260Lm	● 4000K	870x23x36mm	20
203800038	12W	1260Lm	● 6500K	870x23x36mm	20
203800039	16W	1700Lm	● 4000K	1170x23x36mm	20
203800040	16W	1700Lm	● 6500K	1170x23x36mm	20

Kolari

REGLETA

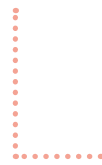

Fácil
instalación



9W

18W

24W

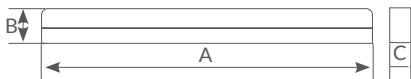

4200K



6500K



120°



≥20.000



≥80Ra



25.000h.



220-240V



50Hz

Regleta electrónica T8 LED

Uso interior.

Referencia	Con difusor / Luminaria (360°)	Sin difusor / Fuente de luz (360°)	Luz	Dimensión (AxBxC)	Embalaje
203800027	9W / 850Lm	9W / 950Lm	● 4200K	600x39.2x27.7mm	20
203800028	9W / 850Lm	9W / 950Lm	● 6500K	600x39.2x27.7mm	20
203800029	18W / 1700Lm	18W / 1900Lm	● 4200K	1200x39.2x27.7mm	20
203800030	18W / 1700Lm	18W / 1900Lm	● 6500K	1200x39.2x27.7mm	20
203800031	24W / 2300Lm	24W / 2600Lm	● 4200K	1500x39.2x27.7mm	20
203800032	24W / 2300Lm	24W / 2600Lm	● 6500K	1500x39.2x27.7mm	20

Nalheri

REGLETA

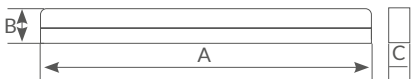

- 5700K
- 120°
- ≥20.000
- ≥80Ra
- 30.000h.
- 220-240V
- 50/60Hz

Regleta LED

Con interruptor. **Interconexionables.** Cable 100mm.
Possibilidad de unir hasta 10 regletas. Uso interior. IK08. PF ≥0.9.

Referencia	Potencia	Lúmenes	Luz	Dimensión (AxBxC)	Embalaje
203800072	40W	4400Lm	● 5700K	1200x40x70mm	20



Bame
REGLETA

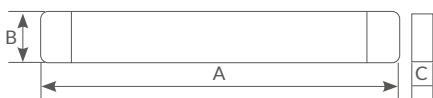

4000K



6000K



110°



>15.000



≥80Ra



25.000h.



170-250V



50/60Hz

Regleta LED

Materia: **plástico**. Cable 150mm. Uso interior. IP20. IK08.

Referencia	Con difusor / Luminaria (360°)	Sin difusor / Fuente de luz (360°)	Luz	Dimensión (AxBxC)	Embalaje
203800068	18W/ 1700Lm	18W/ 1950Lm	● 4000K	600x75x25mm	20
203800069	18W/ 1700Lm	18W/ 1950Lm	● 6000K	600x75x25mm	20
203800070	36W/ 3700Lm	36W/ 4000Lm	● 4000K	1200x75x25mm	20
203800071	36W/ 3700Lm	36W/ 4000Lm	● 6000K	1200x75x25mm	20

Kenge

REGLETA



25W

35W

48W



Fácil
instalación

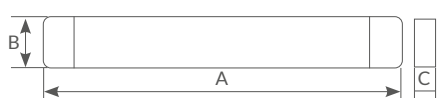

4200K



6500K



110°



≥15.000



≥80Ra



25.000h.



220-240V



50Hz

Regleta techo LED

Fijación en techo. Sin cable, fácil conexionado. Material: **PMMA + aluminio.** Uso interior.

Referencia	Con difusor / Luminaria (360°)	Sin difusor / Fuente de luz (360°)	Luz	Dimensión (AxBxC)	Embalaje
203800054	25W / 2400Lm	25W / 2700Lm	● 4200K	613x120x31mm	12
203800055	25W / 2400Lm	25W / 2700Lm	● 6500K	613x120x31mm	12
203800056	35W / 3200Lm	35W / 3800Lm	● 4200K	913x120x31mm	6
203800057	35W / 3200Lm	35W / 3800Lm	● 6500K	913x120x31mm	6
203800058	48W / 4700Lm	48W / 5200Lm	● 4200K	1213x120x31mm	6
203800059	48W / 4700Lm	48W / 5200Lm	● 6500K	1213x120x31mm	6



Tilani
APLIQUE



4.5W



Caja conexión externa **IP44**.

*Se vende por separado



Para instalación en **pared**.



Para instalación en **armarios**.



Para colocar en espejos de **hasta 8mm**.

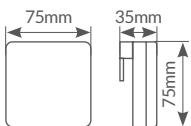

4000K



6500K



110°



>15.000



≥80Ra



25.000h.



IP44



220-240V



50/60Hz

Aplique baño LED

Montaje en **pared y sobre el borde del espejo**. Ideal para baños u otras estancias. Accesorios de instalación incluidos. Material: **PC**. Cable: 300mm.

Referencia	Con difusor / Luminaria (360°)	Sin difusor / Fuente de luz (360°)	Luz	Embalaje
203800062	4.5W / 385Lm	4.5W / 500Lm	● 4000K	100
203800063	4.5W / 385Lm	4.5W / 500Lm	● 6500K	100
203805001	Bolsa 5 unidades conectores IP44 para apliques de baño			



Inada
APLIQUE



4.5W



Caja conexión externa **IP44**.

*Se vende por separado



Para instalación en **pared**.



Para instalación en **armarios**.



Para colocar en espejos de **hasta 8mm**.

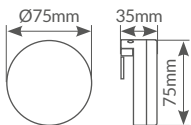

4000K



6500K



110°



>15.000



≥80Ra



25.000h.



IP44



220-240V



50/60Hz

Aplique baño LED

Montaje en **pared y sobre el borde del espejo**. Ideal para baños u otras estancias. Accesorios de intaslación incluidos. Material: **PC**. Cable: 300mm.

Referencia	Con difusor / Luminaria (360°)	Sin difusor / Fuente de luz (360°)	Luz	Embalaje
203800064	4.5W/ 385Lm	4.5W/ 500Lm	● 4000K	100
203800065	4.5W/ 385Lm	4.5W/ 500Lm	● 6500K	100
203805001	Bolsa 5 unidades conectores IP44 para apliques de baño			



Nakur
APLIQUE



6W



Caja conexión externa **IP44**.

*Se vende por separado



Para instalación en **pared**.



Para colocar en espejos de **hasta 7mm**.

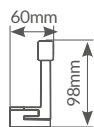
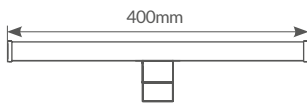

4000K



6500K



110°



>15.000



≥80Ra



25.000h.



IP44



220-240V



50/60Hz

Aplique baño LED

Montaje en **pared y sobre el borde del espejo**. Ideal para baños u otras estancias.
Accesorios de intaslación incluidos. Material: **PC**. Cable: 300mm.

Referencia	Con difusor / Luminaria (360°)	Sin difusor / Fuente de luz (360°)	Luz	Embalaje
203800066	6W / 570Lm	6W / 800Lm	● 4000K	20
203800067	6W / 570Lm	6W / 800Lm	● 6500K	20
203805001	Bolsa 5 unidades conectores IP44 para apliques de baño			

Amnes

APLIQUE



5W



Caja conexión externa **IP44**.



Para instalación en **armarios**.



Para colocar en espejos de **hasta 7mm**.

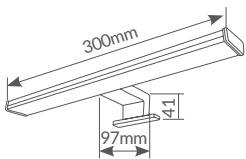

6500K



100°



>15.000



≥80Ra



20.000h.



IP44



230V



50/60Hz

Aplique baño LED

Montaje en **armarios y espejos**. Material: **PC**.
Cable: 300mm. Ideal para baños u otras estancias. **IK04**.

Referencia	Con difusor / Luminaria (360°)	Sin difusor / Fuente de luz (360°)	Luz	Embalaje
203800046	5W / 350Lm	5W / 550Lm	● 6500K	20

Sund
APLIQUE



8W



Caja conexión externa **IP44**.



Para instalación en **pared**.

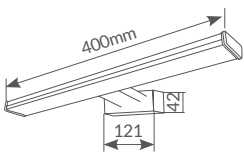

6500K



110°



>15.000



≥80Ra



20.000h.



IP44



220-240V



50/60Hz

Aplique baño LED

Montaje en **pared**. Ideal para baños u otras estancias. Material: **aluminio + PC**. Cable: 100mm. **IK04**.

Referencia	Con difusor / Luminaria (360°)	Sin difusor / Fuente de luz (360°)	Luz	Embalaje
203800045	8W/640Lm	8W/900Lm	● 6500K	20

Laksa

APLIQUE



Caja conexión externa **IP44**.



Para instalación en **pared**.



Para instalación en **armarios**.



Para colocar en espejos de **hasta 7mm**.

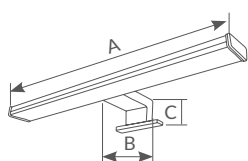

4000K



6500K



110°



>15.000



≥80Ra



25.000h.



220-240V



50/60Hz

Aplicque baño LED

Montaje en **armarios, paredes y espejos**. Ideal para baños u otras estancias. Incluye interruptor.
Material: **aluminio + PC**. Cable: 300mm. **IK04**.

Referencia	Con difusor / Luminaria (360°)	Sin difusor / Fuente de luz (360°)	Luz	Dimensión (AxBxC)	Embalaje
203800041	8W / 640Lm	7.4W / 900Lm	● 4000K	400x112x44mm	20
203800042	8W / 640Lm	7.4W / 900Lm	● 6500K	400x112x44mm	20
203800043	12W / 960Lm	11W / 1350Lm	● 4000K	600x106x42mm	20
203800044	12W / 960Lm	11W / 1350Lm	● 6500K	600x112x44mm	20

Sioux
PANTALLAS



18W

36W

45W



Fácil
instalación

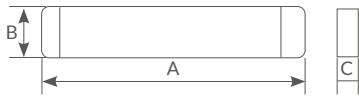

6500K



20.000



≥80Ra



30.000h.



IP65



220-240V



50/60Hz

Pantalla estanca LED

Tipo: **superficie**. Fijación en **techo**. Material: **PC**. Incluye 2 clips, 2 tornillos y 2 tacos.
Sin cable, fácil conexionado. **Protección contra rayos UV**. Uso interior y exterior. **IK8**.

Referencia	Con difusor / Luminaria (360°)	Sin difusor / Fuente de luz (360°)	Luz	Dimensión (AxBxC)	Embalaje
203200008	18W / 1600Lm	18W / 1900Lm	● 6500K	700x53x35mm	20
203200009	36W / 3500Lm	36W / 4000Lm	● 6500K	1230x53x35mm	20
203200010	45W / 4300Lm	45W / 4900Lm	● 6500K	1530x53x35mm	20

Lepola

REGLETAS

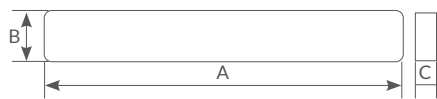

- 6500K
- 120°
- 20.000
- ≥80Ra
- 30.000h.
- 220-240V
- 50/60Hz

Regleta techo LED

Fijación en techo. Preparado para interconectar varias entre sí. Material: **ABS + PC.** Uso exterior. **IP65.**

Referencia	Con difusor / Luminaria (360°)	Sin difusor / Fuente de luz (360°)	Luz	Máx. regletas interconectadas	Dimensión (AxBxC)	Embalaje
203820001	9W / 900Lm	9W / 1100Lm	● 6500K	27	540x60x58mm	20
203820003	18W / 1800Lm	18W / 2400Lm	● 6500K	13	1140x60x58mm	15
203820005	24W / 2400Lm	24W / 3200Lm	● 6500K	10	1440x60x58mm	12

Tupala

REGLETAS

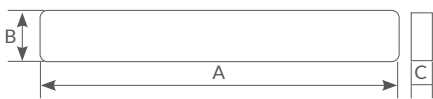

-  6500K
-  120°
-  20.000
-  ≥80Ra
-  30.000h.
-  220-240V
-  Hz

Regleta techo LED

Fijación en techo. Con cable para interconectar entre sí. Material: **ABS + PC.** Uso exterior. **IP65.**

Referencia	Con difusor / Luminaria (360°)	Sin difusor / Fuente de luz (360°)	Luz	Máx. regletas interconectadas	Dimensión (AxBxC)	Embalaje
203820002	18W / 1800Lm	18W / 2400Lm	● 6500K	13	540x78x58mm	15
203820004	36W / 3600Lm	36W / 4600Lm	● 6500K	12	1140x78x58mm	8
203820006	48W / 4800Lm	48W / 6200Lm	● 6500K	9	1440x78x58mm	12

Kiowa
PANTALLAS

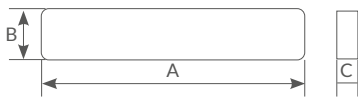
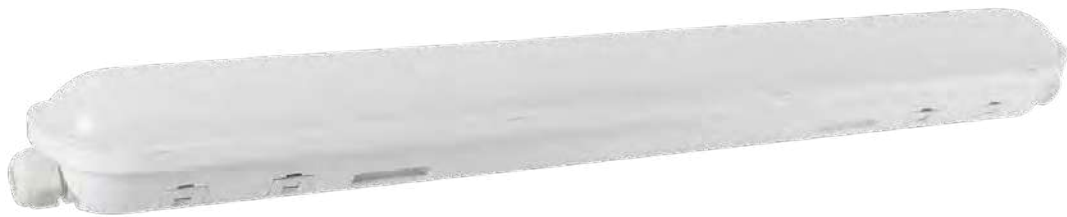

- 6500K
- 30.000
- ≥80Ra
- 50.000h.
- IP65
- 220-240V
- 50/60Hz

Pantalla estanca LED

Tipo: **superficie**. **Fijación en techo**. Material: **PC+ABS**. Incluye 2 clips, 2 tornillos y 2 tacos.
Sin cable, fácil conexionado. **Protección contra rayos UV**. Uso interior y exterior. **IK8**.

Referencia	Con difusor / Luminaria (360°)	Sin difusor / Fuente de luz (360°)	Luz	Dimensión (AxBxC)	Embalaje
203200011	12W / 1440Lm	12W / 1600Lm	6500K	590x72x61mm	20
203200012	24W / 2880Lm	24W / 3300Lm	6500K	1180x72x61mm	15
203200013	33W / 3960Lm	33W / 4600Lm	6500K	1480x72x61mm	12



Atende

REGLETAS

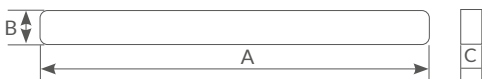

Interior Pantallas y regletas industriales

Regleta industrial para tubos LED

Para tubos LED T8. Carcasa **metálica**. Casquillo: G13.
 Conexionadas en un lateral para instalar tubos de LED a 230V directo. Uso interior.

Referencia	Para tubo (cm)	Tipo de tubo	Dimensión (AxBxC)	Embalaje
203810010	1 x 60cm	T8	599x32x44mm	60
203810011	1 x 120cm	T8	1199x32x44mm	60
203810012	1 x 150cm	T8	1500x32x44mm	60



60cm 120cm 150cm

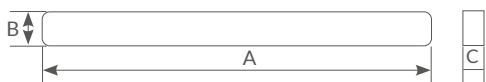

IP20 220-240V 50Hz

Regleta industrial para tubos LED

Para tubos LED T8. Carcasa **metálica**. Casquillo: G13.
Conexionadas en un lateral para instalar tubos de LED a 230V directo. Uso interior.

Referencia	Para tubo (cm)	Tipo de tubo	Dimensión (AxBxC)	Embalaje
203810005	2 x 60cm	T8	599x72x40mm	60
203810006	2 x 120cm	T8	1199x72x40mm	60
203810007	2 x 150cm	T8	1500x72x40mm	60



9W

18W

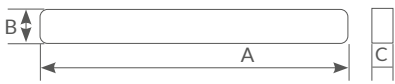

6500K



160°



15.000



≥80Ra



35.000h.



IP20



165-260V



50/60Hz

Regleta industrial con tubo LED

Fijación en techo. Material tubo: **nanoplástico**. Material regleta: **metal**. Uso interior.

Referencia	Con difusor / Luminaria (360°)	Sin difusor / Fuente de luz (360°)	Luz	Máx. regletas interconectadas	Dimensión (AxBxC)	Embalaje
203810008	9W / 810Lm	9W / 1100Lm	● 6500K	27	599x32x44mm	24
203810009	18W / 1620Lm	18W / 2400Lm	● 6500K	13	1199x32x44mm	24



A Para un tubo

60cm 120cm 150cm



B Para 2 tubos

60cm 120cm 150cm



C Bolsa accesorios

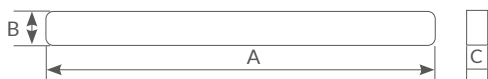

Pantalla estanca LED



IP65



220-240V



50Hz

Para tubos fluorescentes T8. Estructura **ABS** y **tapa policarbonato**.
Conexionadas **para instalar tubos de LED a 230V directo**. Uso interno y externo.

Referencia	Artículo	Para tubo (cm)	Tipo de tubo	Dimensión (AxBxC)	Embalaje
203200014	A	1x 60cm	T8	650x80x90mm	10
203200015	A	1x 120cm	T8	1250x80x90mm	8
203200016	A	1x 150cm	T8	1550x80x90mm	8
203200017	B	2x 60cm	T8	650x150x90mm	6
203200018	B	2x 120cm	T8	1250x150x90mm	6
203200019	B	2x 150cm	T8	1550x150x90mm	4
203215007	C	Bolsa 10 clips, tornillos y enganches			

* Consulta el conexionado en el apartado info técnica.



